

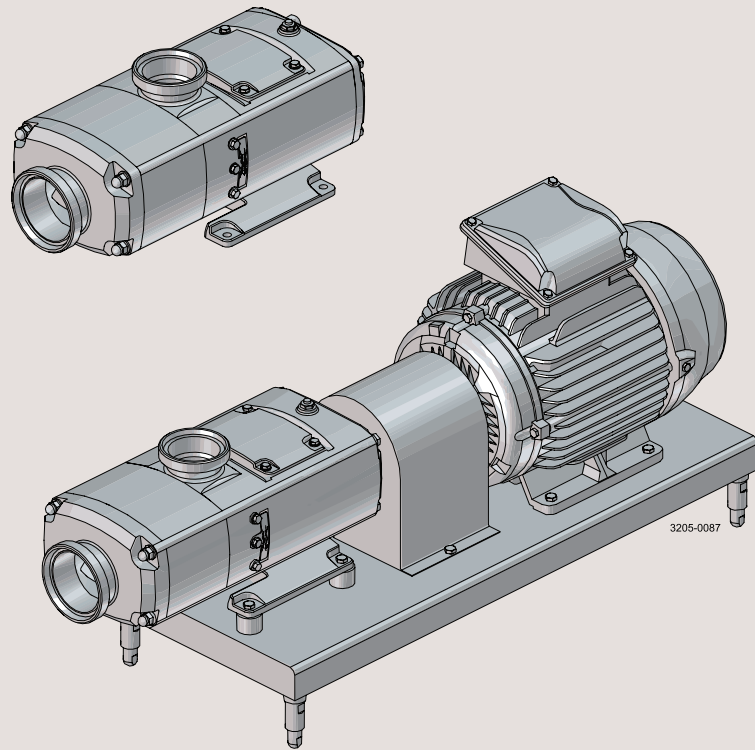

Spare Parts

OS Twin Screw Pump Range



10000821-EN11 2022-12

Original manual

The information herein is correct at the time of issue but may be subject to change without prior notice

1. OS 12–14–16 Twin Screw Pump Range	4
2. OS 22–24–26 Twin Screw Pump Range	8
3. OS 32–34–36 Twin Screw Pump Range	12
4. OS 42–44–46 Twin Screw Pump Range	16
5. Cartridge Seal	20
6. Twin Screw Pump Range – Single Seal	22
7. Twin Screw Pump Range – Single Flushed Seal	26
8. Twin Screw Pump Range – Double Seal	30
9. Twin Screw Service Kits	34

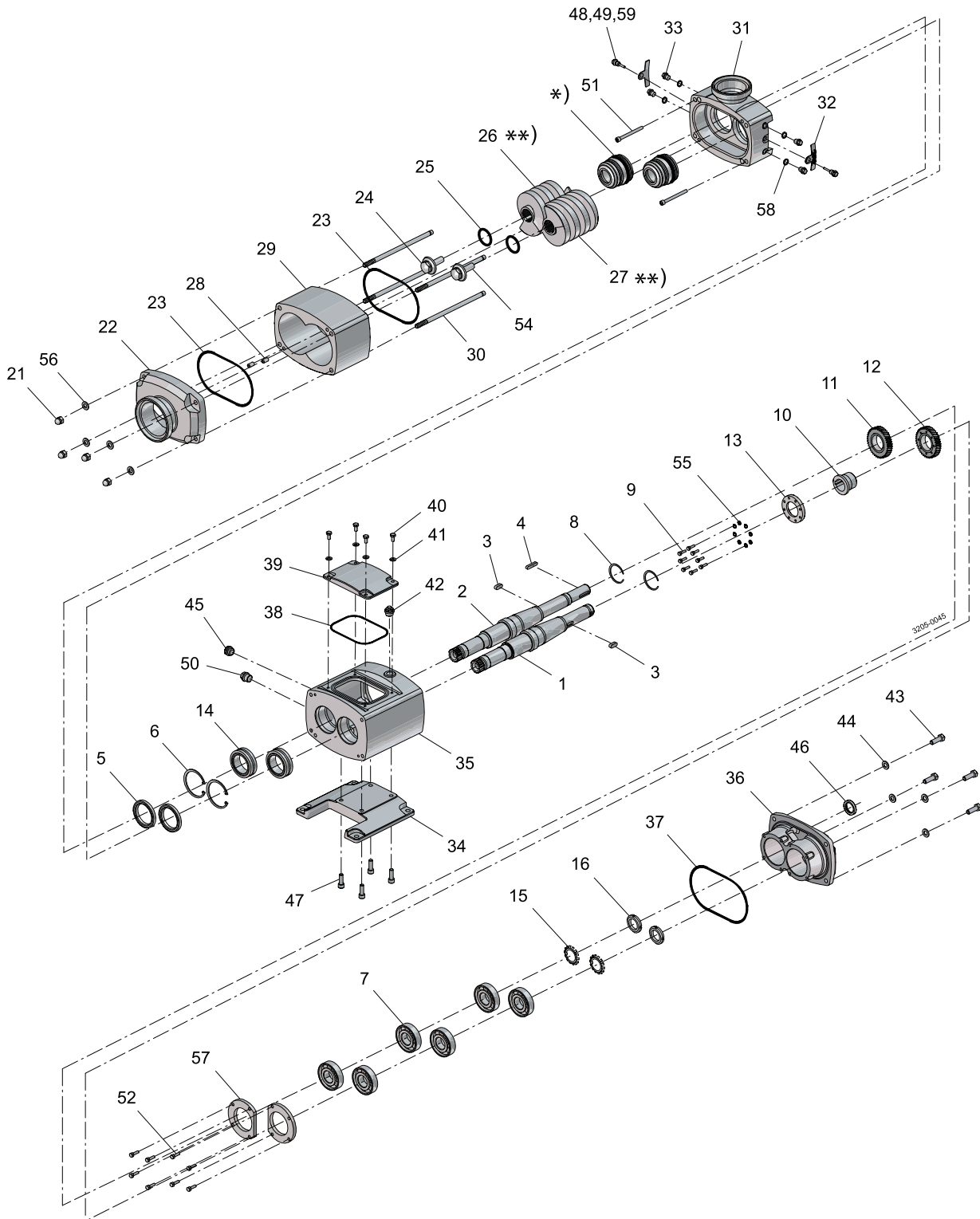

Pos	Qty	Denomination	Item no. OS12	Item no. OS14	Item no. OS16
01	1	Auxiliary Shaft	9650100101	9650100101	9650100101
02	1	Drive Shaft	9650100201	9650100201	9650100201
03	1	Gear Key	9650100301	9650100301	9650100301
04	1	Drive Shaft Key	9650100401	9650100401	9650100401
05 ^Δ	2	Front Lip Seal	9650100501	9650100501	9650100501
06	2	Circlip	9650100601	9650100601	9650100601
07	6	Bearing	9650100701	9650100701	9650100701
08	2	Circlip	9650100801	9650100801	9650100801
09	8	Gear Sleeve Bolts	9650100901	9650100901	9650100901
10	1	Gear Sleeve	9650101001	9650101001	9650101001
11	1	Timing Gear, Drive Shaft	9650101101	9650101101	9650101101
12	1	Timing Gear, Auxiliary Shaft	9650101201	9650101201	9650101201
13	1	Timing Gear, Clamp Plate	9650101301	9650101301	9650101301
14	2	Bearing	9650101401	9650101401	9650101401
15	2	Tab Washer	9650101501	9650101501	9650101501
16	2	Bearing Nut	9650101601	9650101601	9650101601
21	4	Pump Cover Nut	9650102101	9650102101	9650102101
22	1	Pump Cover, DIN11851 80mm	9650102201	9650102201	9650102201
	1	Pump Cover, DIN11851 65mm	9650102202	9650102202	9650102202
	1	Pump Cover, DIN11851 50mm	9650102203	9650102203	9650102203
	1	Pump Cover, Tri-Clamp 80mm	9650102204	9650102204	9650102204
	1	Pump Cover, Tri-Clamp 65mm	9650102205	9650102205	9650102205
	1	Pump Cover, Tri-Clamp 50mm	9650102206	9650102206	9650102206
	1	Pump Cover, RJT 80mm	9650102207	9650102207	9650102207
	1	Pump Cover, RJT 65mm	9650102208	9650102208	9650102208
	1	Pump Cover, RJT 50mm	9650102209	9650102209	9650102209
	1	Pump Cover, SMS 80mm	9650102210	9650102210	9650102210
	1	Pump Cover, SMS 65mm	9650102211	9650102211	9650102211
	1	Pump Cover, SMS 50mm	9650102212	9650102212	9650102212
	1	Pump Cover, IDF 80mm	9650102213	9650102213	9650102213
	1	Pump Cover, IDF 65mm	9650102214	9650102214	9650102214
	1	Pump Cover, IDF 50mm	9650102215	9650102215	9650102215
	1	Pump Cover, DIN11864-1-A 80mm	9650102216	9650102216	9650102216
	1	Pump Cover, DIN11864-1-A 65mm	9650102217	9650102217	9650102217
	1	Pump Cover, DIN11864-1-A 50mm	9650102218	9650102218	9650102218
	1	Pump Cover, DIN11864-1-C 80mm	9650102219	9650102219	9650102219
	1	Pump Cover, DIN11864-1-C 65mm	9650102220	9650102220	9650102220
	1	Pump Cover, DIN11864-1-C 50mm	9650102221	9650102221	9650102221
	1	Pump Cover, DIN11864-2-A 80mm	9650102222	9650102222	9650102222
	1	Pump Cover, DIN11864-2-A 65mm	9650102223	9650102223	9650102223
	1	Pump Cover, DIN11864-2-A 50mm	9650102224	9650102224	9650102224
	1	Pump Cover, DIN11864-2-C 80mm	9650102225	9650102225	9650102225
	1	Pump Cover, DIN11864-2-C 65mm	9650102226	9650102226	9650102226
	1	Pump Cover, DIN11864-2-C 50mm	9650102227	9650102227	9650102227
	1	Pump Cover, Rectangular	9650102299	9650102299	9650102299
23 [▲]	2	Pump Casing, Elastomer EPDM	9650102301	9650102301	9650102301
	2	Pump Casing, Elastomer FPM	9650102302	9650102302	9650102302
	2	Pump Casing, Elastomer FFPM	9650102303	9650102303	9650102303
24	2	Feed Screw Nut	9650102401	9650102401	9650102401
25 [▲]	2	Feed Screw, Elastomer EPDM	9650202501	9650202501	9650202501
	2	Feed Screw, Elastomer FPM	9650202502	9650202502	9650202502
	2	Feed Screw, Elastomer FFPM	9650202503	9650202503	9650202503
26	1	Feed Screw, Left Standard	9650122601	9650142601	9650162601
	1	Feed Screw, Left Hardened	9650122602	9650142602	9650162602
27	1	Feed Screw, Right Standard	9650122701	9650142701	9650162701
	1	Feed Screw, Right Hardened	9650122702	9650142702	9650162702
28	6	Pump Casing, Dowels	9650002801	9650002801	9650002801
29	1	Pump Casing, Hardened	9650102901	9650102901	9650102901
	1	Pump Casing, Hardened For Heating Jacket	9650102903	9650102903	9650102903

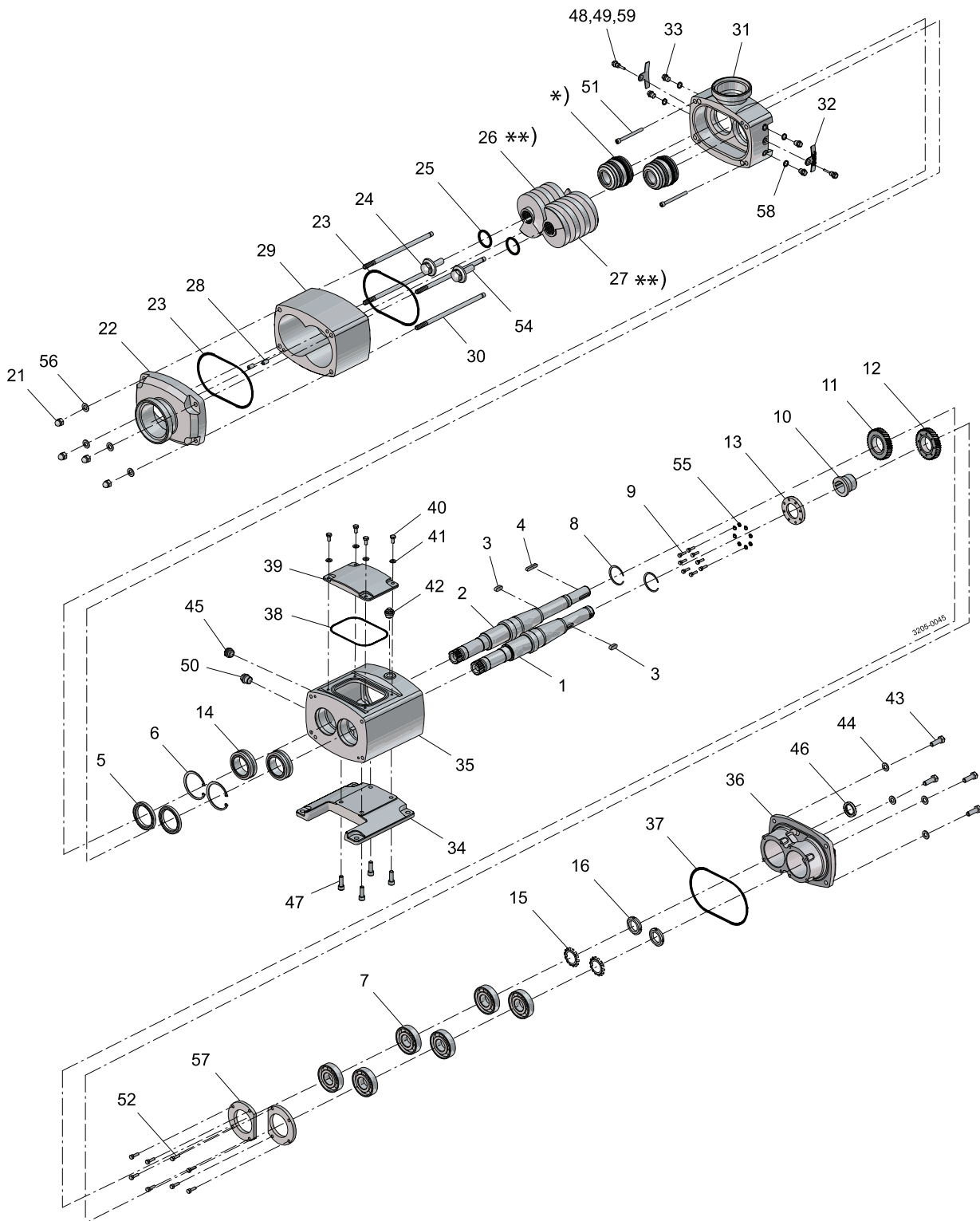

*** Cartridge Seal**
**** When replacing Feed Screw it is recommended to replace both Left and Right version**

OS 12-14-16 Twin Screw Pump Range

Pos	Qty	Denomination	Item no. OS12	Item no. OS14	Item no. OS16
30	4	Pump Casing Studs	9650103001	9650103001	9650103001
31	1	Seal Housing, DIN11851 65mm	9650103101	9650103101	9650103101
	1	Seal Housing, DIN11851 50mm	9650103102	9650103102	9650103102
	1	Seal Housing, DIN11851 40mm	9650103103	9650103103	9650103103
	1	Seal Housing, Tri-Clamp 65mm	9650103104	9650103104	9650103104
	1	Seal Housing, Tri-Clamp 50mm	9650103105	9650103105	9650103105
	1	Seal Housing, Tri-Clamp 40mm	9650103106	9650103106	9650103106
	1	Seal Housing, RJT 65mm	9650103107	9650103107	9650103107
	1	Seal Housing, RJT 50mm	9650103108	9650103108	9650103108
	1	Seal Housing, RJT 40mm	9650103109	9650103109	9650103109
	1	Seal Housing, SMS 65mm	9650103110	9650103110	9650103110
	1	Seal Housing, SMS 50mm	9650103111	9650103111	9650103111
	1	Seal Housing, SMS 40mm	9650103112	9650103112	9650103112
	1	Seal Housing, IDF 65mm	9650103113	9650103113	9650103113
	1	Seal Housing, IDF 50mm	9650103114	9650103114	9650103114
	1	Seal Housing, IDF 40mm	9650103115	9650103115	9650103115
	1	Seal Housing, DIN11864-1-A 65mm	9650103116	9650103116	9650103116
	1	Seal Housing, DIN11864-1-A 50mm	9650103117	9650103117	9650103117
	1	Seal Housing, DIN11864-1-A 40mm	9650103118	9650103118	9650103118
	1	Seal Housing, DIN11864-1-C 65mm	9650103119	9650103119	9650103119
	1	Seal Housing, DIN11864-1-C 50mm	9650103120	9650103120	9650103120
	1	Seal Housing, DIN11864-1-C 40mm	9650103121	9650103121	9650103121
	1	Seal Housing, DIN11864-2-A 65mm	9650103122	9650103122	9650103122
	1	Seal Housing, DIN11864-2-A 50mm	9650103123	9650103123	9650103123
	1	Seal Housing, DIN11864-2-A 40mm	9650103124	9650103124	9650103124
	1	Seal Housing, DIN11864-2-C 65mm	9650103125	9650103125	9650103125
	1	Seal Housing, DIN11864-2-C 50mm	9650103126	9650103126	9650103126
	1	Seal Housing, DIN11864-2-C 40mm	9650103127	9650103127	9650103127
32	2	Gland Guard	9650103201	9650103201	9650103201
33	4	Flush Plugs	9650103301	9650103301	9650103301
	4	Flush Caps	9650103302	9650103302	9650103302
34	1	Foot	9650103401	9650103401	9650103401
35	1	Gearbox	9650103501	9650103501	9650103501
36	1	Gearbox End Cover	9650103601	9650103601	9650103601
37 Δ	1	Gearbox End Cover, O Ring	9650103701	9650103701	9650103701
38 Δ	1	Gearbox Top Cover, O Ring	9650103801	9650103801	9650103801
39	1	Gearbox Top Cover	9650103901	9650103901	9650103901
40	4	Gearbox Top Cover, Bolts	9650004001	9650004001	9650004001
41	4	Gearbox Top Cover, Washers	9650004101	9650004101	9650004101
42	1	Filler Plug	9650004201	9650004201	9650004201
43	4	Gearbox, End Cover Bolts	9650104301	9650104301	9650104301
44	4	Gearbox, End Cover Washers	9650204401	9650204401	9650204401
45	1	Sight Glass	9650004501	9650004501	9650004501
46 Δ	1	Rear Lip Seal	9650104601	9650104601	9650104601
47	4	Gearbox Foot Screw	9650104701	9650104701	9650104701
48	2	Gland Guard, Plug	9650004801	9650004801	9650004801
49	2	Seal Pin	9650104901	9650104901	9650104901
50	1	Washer Gearbox, Plug	9650005001	9650005001	9650005001
51	2	Cap screw	9650105101	9650105101	9650105101
52	8	Hex bolt	9650105201	9650105201	9650105201
54	2	Stud bolt	9650105401	9650105401	9650105401
55	1	Washer	9650105501	9650105501	9650105501
56	4	Washer	9650204401	9650204401	9650204401
57	2	Bearing Retainer	9650105701	9650105701	9650105701
58	4	Washer Seal Ring	9650005801	9650005801	9650005801
59 ▲	2	Gland Guard Screw, O Ring FPM	9650005901	9650005901	9650005901
60	2	Heating Pipe Union, - Not Shown	9650306001	9650306001	9650306001
61	2	Heating Pipe Elbow, - Not Shown	9650306101	9650306101	9650306101
62	1	Heating Pipe, - Not Shown	9650106201	9650106201	9650106201

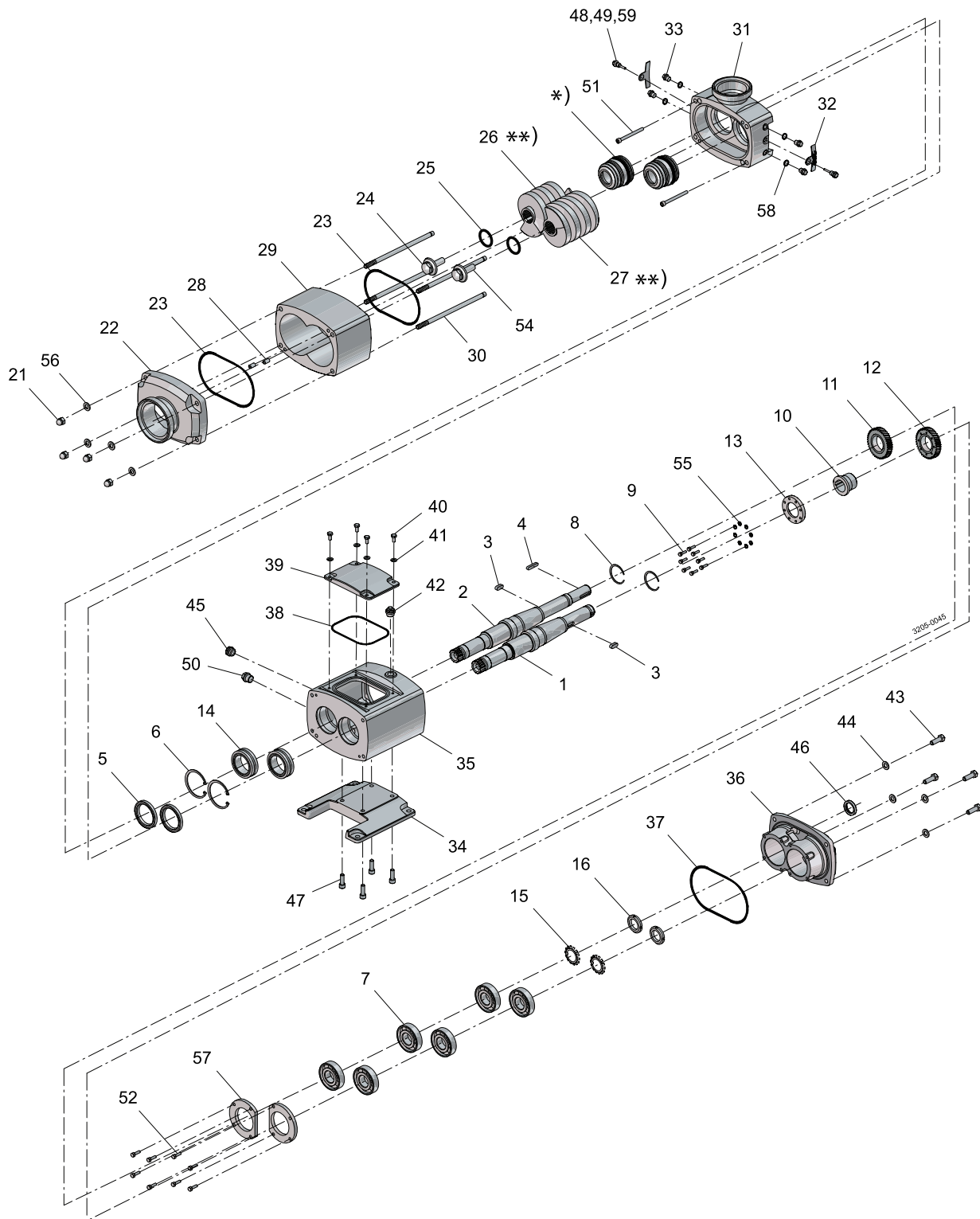

* Cartridge Seal
 ** When replacing Feed Screw it is recommended to replace both Left and Right version

OS 22-24-26 Twin Screw Pump Range

Pos	Qty	Denomination	Item no. OS22	Item no. OS24	Item no. OS26
1	1	Auxiliary Shaft	9650200101	9650200101	9650200101
2	1	Drive Shaft	9650200201	9650200201	9650200201
3	1	Gear Key	9650200301	9650200301	9650200301
4	1	Drive Shaft Key	9650200401	9650200401	9650200401
5	2	Front Lip Seal	9650200501	9650200501	9650200501
6	2	Circlip	9650200601	9650200601	9650200601
7	6	Ball Bearing	9650200701	9650200701	9650200701
8	2	Circlip	9650200801	9650200801	9650200801
9	8	Gear Sleeve Bolts	9650200901	9650200901	9650200901
10	1	Gear Sleeve	9650201001	9650201001	9650201001
11	1	Timing Gear Drive Shaft	9650201101	9650201101	9650201101
12	1	Timing Gear Auxilliary Shaft	9650201201	9650201201	9650201201
13	1	Timing Gear Clamp Plate	9650201301	9650201301	9650201301
14	2	Needle Bearing	9650201401	9650201401	9650201401
15	2	Tab Washer	9650201501	9650201501	9650201501
16	2	Bearing Nut	9650201601	9650201601	9650201601
21	4	Front Cover Nut	9650202101	9650202101	9650202101
22	1	Pump Cover, DIN11851 80mm	9650202201	9650202201	9650202201
	1	Pump Cover, DIN11851 65m	9650202202	9650202202	9650202202
	1	Pump Cover, DIN11851 50mm	9650202203	9650202203	9650202203
	1	Pump Cover, Tri-Clamp 80m	9650202204	9650202204	9650202204
	1	Pump Cover, Tri-Clamp 65mm	9650202205	9650202205	9650202205
	1	Pump Cover, Tri-Clam 50mm	9650202206	9650202206	9650202206
	1	Pump Cover, RJT 80mm	9650202207	9650202207	9650202207
	1	Pump Cover, RJT 65mm	9650202208	9650202208	9650202208
	1	Pump Cover, RJT 50mm	9650202209	9650202209	9650202209
	1	Pump Cover, SMS 80mm	9650202210	9650202210	9650202210
	1	Pump Cover, SMS 65mm	9650202211	9650202211	9650202211
	1	Pump Cover, SMS 50mm	9650202212	9650202212	9650202212
	1	Pump Cover, IDF 80mm	9650202213	9650202213	9650202213
	1	Pump Cover, IDF 65mm	9650202214	9650202214	9650202214
	1	Pump Cover, IDF 50mm	9650202215	9650202215	9650202215
	1	Pump Cover, DIN11864-1-A 80mm	9650202216	9650202216	9650202216
	1	Pump Cover, DIN11864-1-A 65mm	9650202217	9650202217	9650202217
	1	Pump Cover, DIN11864-1-A 50mm	9650202218	9650202218	9650202218
	1	Pump Cover, DIN11864-1-C 80mm	9650202219	9650202219	9650202219
	1	Pump Cover, DIN11864-1-C 65mm	9650202220	9650202220	9650202220
	1	Pump Cover, DIN11864-1-C 50mm	9650202221	9650202221	9650202221
	1	Pump Cover, DIN11864-2-A 80mm	9650202222	9650202222	9650202222
	1	Pump Cover, DIN11864-2-A 65mm	9650202223	9650202223	9650202223
	1	Pump Cover, DIN11864-2-A 50mm	9650202224	9650202224	9650202224
	1	Pump Cover, DIN11864-2-C 80mm	9650202225	9650202225	9650202225
	1	Pump Cover, DIN11864-2-C 65mm	9650202226	9650202226	9650202226
	1	Pump Cover, DIN11864-2-C 50mm	9650202227	9650202227	9650202227
	1	Pump Cover, Rectangular	9650202299	9650202299	9650202299
23	2	Pump Casing Elastomer, EPDM	9650202301	9650202301	9650202301
	2	Pump Casing Elastomer, FPM	9650202302	9650202302	9650202302
	2	Pump Casing Elastomer, FFPM	9650202303	9650202303	9650202303
24	2	Feed Screw Nut	9650202401	9650202401	9650202401
25	2	Feed Screw Elastomer, EPDM	9650202501	9650202501	9650202501
	2	Feed Screw Elastomer, FPM	9650202502	9650202502	9650202502
	2	Feed Screw Elastomer, FFPM	9650202503	9650202503	9650202503
26	1	Feed Screw, Left Stanard	9650222601	9650242601	9650262601
	1	Feed Screw, Left Hardened	9650222602	9650242602	9650262602
27	1	Feed Screw, Right Standard	9650222701	9650242701	9650262701
	1	Feed Screw, Right Hardened	9650222702	9650242702	9650262702
28	6	Pump Casing Dowels	9650002801	9650002801	9650002801
29	1	Pump Casing, Hardened	9650202901	9650202901	9650202901
	1	Pump Casing, Hardened For Heating Jacket	9650202903	9650202903	9650202903

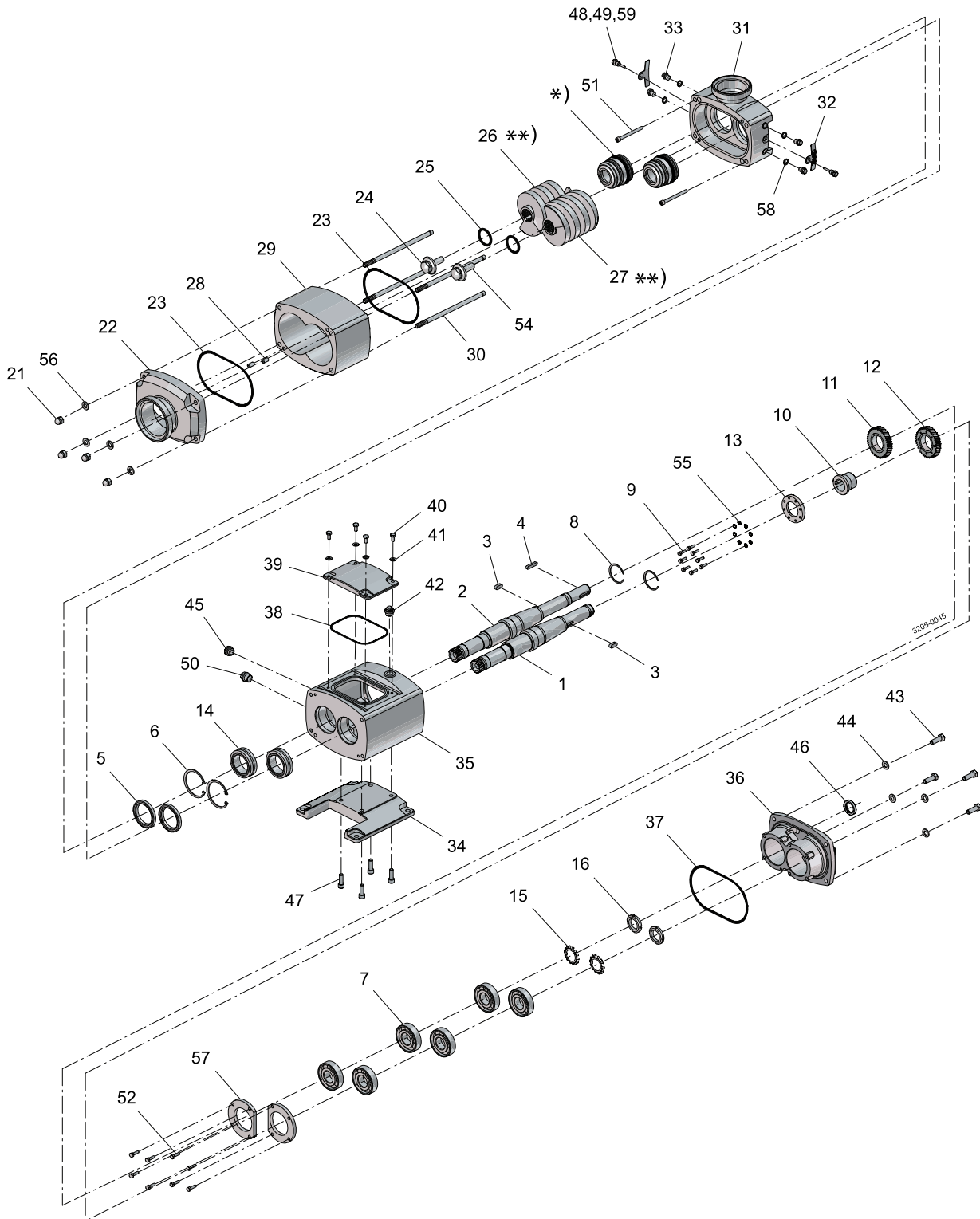

* Cartridge Seal
 ** When replacing Feed Screw it is recommended to replace both Left and Right version

Pos	Qty	Denomination	Item no.	Item no.	Item no.
			OS22	OS24	OS26
30	4	Pump Casing Studs, M10x200	9650203001	9650203001	9650203001
31	1	Seal Housing, DIN11851 65mm	9650203101	9650203101	9650203101
	1	Seal Housing, DIN11851 50mm	9650203102	9650203102	9650203102
	1	Seal Housing, DIN11851 40mm	9650203103	9650203103	9650203103
	1	Seal Housing, Tri-Clamp 65mm	9650203104	9650203104	9650203104
	1	Seal Housing, Tri-Clamp 50mm	9650203105	9650203105	9650203105
	1	Seal Housing, Tri-Clamp 40mm	9650203106	9650203106	9650203106
	1	Seal Housing, RJT 65mm	9650203107	9650203107	9650203107
	1	Seal Housing, RJT 50mm	9650203108	9650203108	9650203108
	1	Seal Housing, RJT 40mm	9650203109	9650203109	9650203109
	1	Seal Housing, SMS 65mm	9650203110	9650203110	9650203110
	1	Seal Housing, SMS 50mm	9650203111	9650203111	9650203111
	1	Seal Housing, SMS 40mm	9650203112	9650203112	9650203112
	1	Seal Housing, IDF 65mm	9650203113	9650203113	9650203113
	1	Seal Housing, IDF 50mm	9650203114	9650203114	9650203114
	1	Seal Housing, IDF 40mm	9650203115	9650203115	9650203115
	1	Seal Housing, DIN11864-1-A 65mm	9650203116	9650203116	9650203116
	1	Seal Housing, DIN11864-1-A 50mm	9650203117	9650203117	9650203117
	1	Seal Housing, DIN11864-1-A 40mm	9650203118	9650203118	9650203118
	1	Seal Housing, DIN11864-1-C 65mm	9650203119	9650203119	9650203119
	1	Seal Housing, DIN11864-1-C 50mm	9650203120	9650203120	9650203120
	1	Seal Housing, DIN11864-1-C 40mm	9650203121	9650203121	9650203121
	1	Seal Housing, DIN11864-2-A 65mm	9650203122	9650203122	9650203122
	1	Seal Housing, DIN11864-2-A 50mm	9650203123	9650203123	9650203123
	1	Seal Housing, DIN11864-2-A 40mm	9650203124	9650203124	9650203124
	1	Seal Housing, DIN11864-2-C 65mm	9650203125	9650203125	9650203125
	1	Seal Housing, DIN11864-2-C 50mm	9650203126	9650203126	9650203126
	1	Seal Housing, DIN11864-2-C 40mm	9650203127	9650203127	9650203127
32	2	Gland Guard	9650203201	9650203201	9650203201
33	4	Flush Plugs	9650203301	9650203301	9650203301
	4	Flush Caps	9650203302	9650203302	9650203302
34	1	Foot	9650203401	9650203401	9650203401
35	1	Gearbox	9650203501	9650203501	9650203501
36	1	Gearbox End Cover	9650203601	9650203601	9650203601
37 Δ	1	Gearbox End Cover O-Ring	9650203701	9650203701	9650203701
38 Δ	1	Gearbox Top Cover O-Ring	9650203801	9650203801	9650203801
39	1	Gearbox Top Cover	9650203901	9650203901	9650203901
40	4	Gearbox Top Cover Bolts	9650004001	9650004001	9650004001
41	4	Gearbox Top Cover Washers	9650004101	9650004101	9650004101
42	1	Filler Plug	9650004201	9650004201	9650004201
43	4	Gearbox End Cover Bolts	9650204301	9650204301	9650204301
44	4	Gearbox End Cover Washers	9650204401	9650204401	9650204401
45	1	Sight Glass	9650004501	9650004501	9650004501
46 Δ	1	Rear Lip Seal	9650204601	9650204601	9650204601
47	4	Gearbox Foot Screw	9650204701	9650204701	9650204701
48	2	Gland Guard Plug	9650004801	9650004801	9650004801
49	2	Seal Pin	9650204901	9650204901	9650204901
50	1	Washer Gearbox Plug	9650005001	9650005001	9650005001
51	2	Cap Screw	9650205101	9650205101	9650205101
52	8	Hex Bolt	9650205201	9650205201	9650205201
54	2	Stud bolt	9650205401	9650205401	9650205401
55	1	Washer	9650205501	9650205501	9650205501
56	4	Washer	9650204401	9650204401	9650204401
57	2	Bearing Retainer	9650205701	9650205701	9650205701
58	4	Washer Seal Ring	9650005801	9650005801	9650005801
59 ▲	2	Gland Guard Screw O Ring, FPM	9650005901	9650005901	9650005901
60	2	Heating Pipe Union - Not shown	9650306001	9650306001	9650306001
61	2	Heating Pipe Elbow - Not shown	9650306101	9650306101	9650306101
62	1	Heating Pipe - Not shown	9650206201	9650206201	9650206201

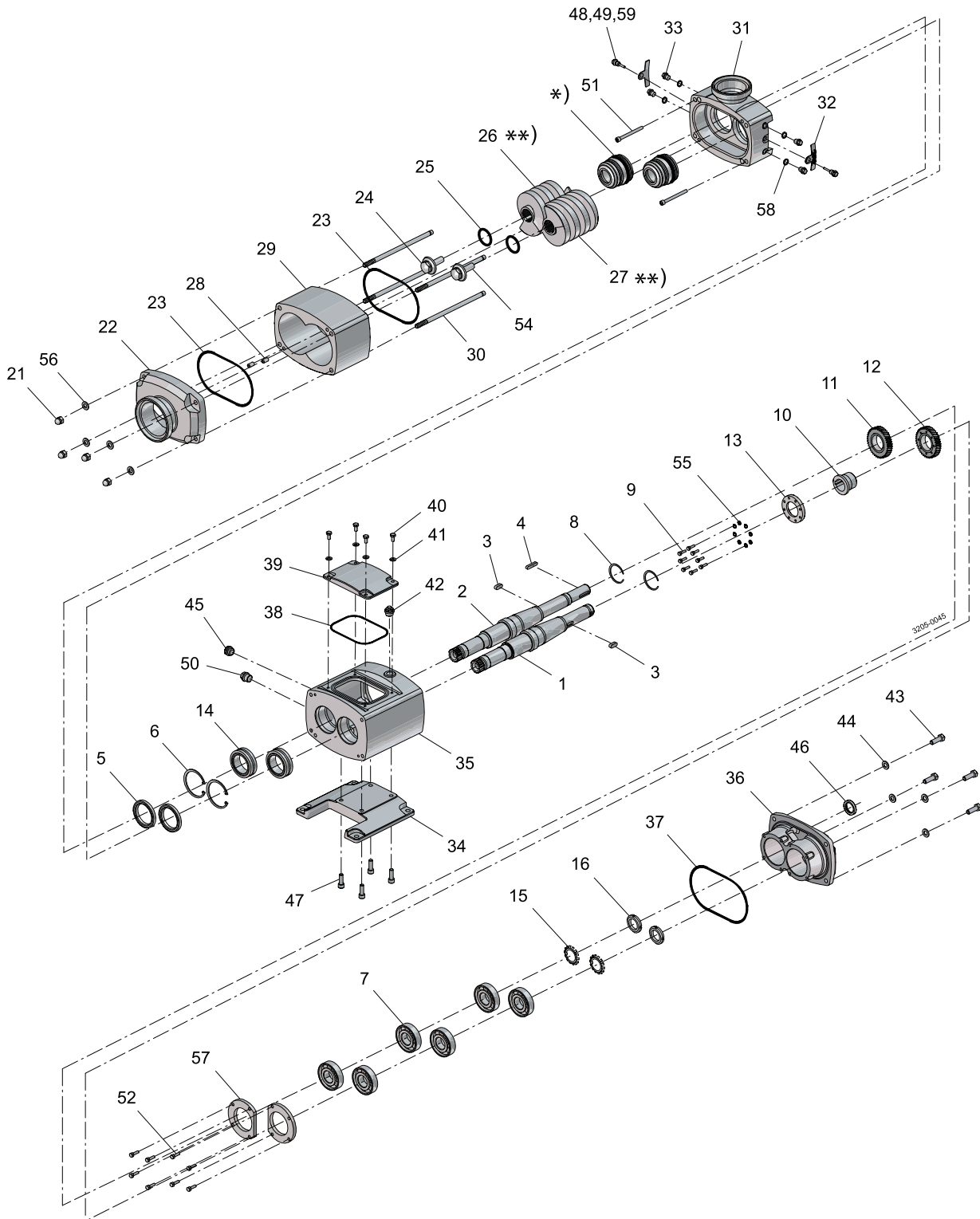

*** Cartridge Seal**
**** When replacing Feed Screw it is recommended to replace both Left and Right version**

Pos	Qty	Denomination	Item no.	Item no.	Item no.
			OS32	OS34	OS36
1	1	Auxiliary Shaft	9650300101	9650300101	9650300101
2	1	Drive Shaft	9650300201	9650300201	9650300201
3	1	Gear Key	9650300301	9650300301	9650300301
4	1	Drive Shaft Key	9650300401	9650300401	9650300401
5	2	Front Lip Seal	9650300501	9650300501	9650300501
6	2	Circlip	9650300601	9650300601	9650300601
7	6	Ball Bearing	9650300701	9650300701	9650300701
8	2	Circlip	9650300801	9650300801	9650300801
9	2	Gear Sleeve Bolts	9650300901	9650300901	9650300901
10	1	Gear Sleeve	9650301001	9650301001	9650301001
11	1	Timing Gear Drive Shaft	9650301101	9650301101	9650301101
12	1	Timing Gear Auxilliary Shaft	9650301201	9650301201	9650301201
13	1	Bearing Retainer	9650301301	9650301301	9650301301
14	2	Needle Bearing	9650301401	9650301401	9650301401
15	2	Tab Washer	9650301501	9650301501	9650301501
16	2	Bearing Nut	9650301601	9650301601	9650301601
21	4	Pump Cover Nuts	9650302101	9650302101	9650302101
22	1	Pump Cover, DIN11851 100mm	9650302201	9650302201	9650302201
	1	Pump Cover, DIN11851 80mm	9650302202	9650302202	9650302202
	1	Pump Cover, Tri-Clamp 100mm	9650302203	9650302203	9650302203
	1	Pump Cover, Tri-Clamp 80mm	9650302204	9650302204	9650302204
	1	Pump Cover, RJT 100mm	9650302205	9650302205	9650302205
	1	Pump Cover, RJT 80mm	9650302206	9650302206	9650302206
	1	Pump Cover, SMS 100mm	9650302207	9650302207	9650302207
	1	Pump Cover, SMS 80mm	9650302208	9650302208	9650302208
	1	Pump Cover, IDF 100mm	9650302209	9650302209	9650302209
	1	Pump Cover, IDF 80mm	9650302210	9650302210	9650302210
	1	Pump Cover, DIN11864-1-A 100mm	9650302211	9650302211	9650302211
	1	Pump Cover, DIN11864-1-A 80mm	9650302212	9650302212	9650302212
	1	Pump Cover, DIN11864-1-C 100mm	9650302213	9650302213	9650302213
	1	Pump Cover, DIN11864-1-C 80mm	9650302214	9650302214	9650302214
	1	Pump Cover, DIN11864-2-A 100mm	9650302215	9650302215	9650302215
	1	Pump Cover, DIN11864-2-A 80mm	9650302216	9650302216	9650302216
	1	Pump Cover, DIN11864-2-C 100mm	9650302217	9650302217	9650302217
	1	Pump Cover, DIN11864-2-C 80mm	9650302218	9650302218	9650302218
	1	Pump Cover, Rectangular	9650302299	9650302299	9650302299
23	2	Pump Casing Elastomer, EPDM	9650302301	9650302301	9650302301
	2	Pump Casing Elastomer, FPM	9650302302	9650302302	9650302302
	2	Pump Casing Elastomer, FFPM	9650302303	9650302303	9650302303
24	2	Feed Screw Nut	9650302401	9650302401	9650302401
25	2	Feed Screw Elastomer, EPDM	9650302501	9650302501	9650302501
	2	Feed Screw Elastomer, FPM	9650302502	9650302502	9650302502
	2	Feed Screw Elastomer, FFPM	9650302503	9650302503	9650302503
26	1	Feed Screw, Left Standard	9650322601	9650342601	9650362601
	1	Feed Screw, Left Hardened	9650322602	9650342602	9650362602
27	1	Feed Screw, Right Standard	9650322701	9650342701	9650362701
	1	Feed Screw, Right Hardened	9650322702	9650342702	9650362702
28	6	Pump Casing, Dowels	9650002801	9650002801	9650002801
29	1	Pump Casing, Hardened	9650302901	9650302901	9650302901
	1	Pump Casing, Hardened For Heating Jacket	9650302903	9650302903	9650302903
30	4	Pump Casing, Studs	9650303001	9650303001	9650303001
31	1	Seal Housing, DIN11851 80mm	9650303101	9650303101	9650303101
	1	Seal Housing, DIN11851 65mm	9650303102	9650303102	9650303102
	1	Seal Housing, Tri-Clamp 80mm	9650303103	9650303103	9650303103
	1	Seal Housing, Tri-Clamp 65mm	9650303104	9650303104	9650303104
	1	Seal Housing, RJT 80mm	9650303105	9650303105	9650303105
	1	Seal Housing, RJT 65mm	9650303106	9650303106	9650303106
	1	Seal Housing, SMS 80mm	9650303107	9650303107	9650303107
	1	Seal Housing, SMS 65mm	9650303108	9650303108	9650303108
	1	Seal Housing, IDF 80mm	9650303109	9650303109	9650303109
	1	Seal Housing, IDF 65mm	9650303110	9650303110	9650303110
	1	Seal Housing, DIN11864-1-A 80mm	9650303111	9650303111	9650303111
	1	Seal Housing, DIN11864-1-A 65mm	9650303112	9650303112	9650303112
	1	Seal Housing, DIN11864-1-C 80mm	9650303113	9650303113	9650303113
	1	Seal Housing, DIN11864-1-C 65mm	9650303114	9650303114	9650303114
	1	Seal Housing, DIN11864-2-A 80mm	9650303115	9650303115	9650303115
	1	Seal Housing, DIN11864-2-A 65mm	9650303116	9650303116	9650303116
	1	Seal Housing, DIN11864-2-C 80mm	9650303117	9650303117	9650303117
	1	Seal Housing, DIN11864-2-C 65mm	9650303118	9650303118	9650303118
32	2	Gland Guard	9650303201	9650303201	9650303201
33	4	Flush Plugs	9650203301	9650203301	9650203301
	4	Flush Caps	9650303302	9650303302	9650303302
34	1	Foot	9650303401	9650303401	9650303401

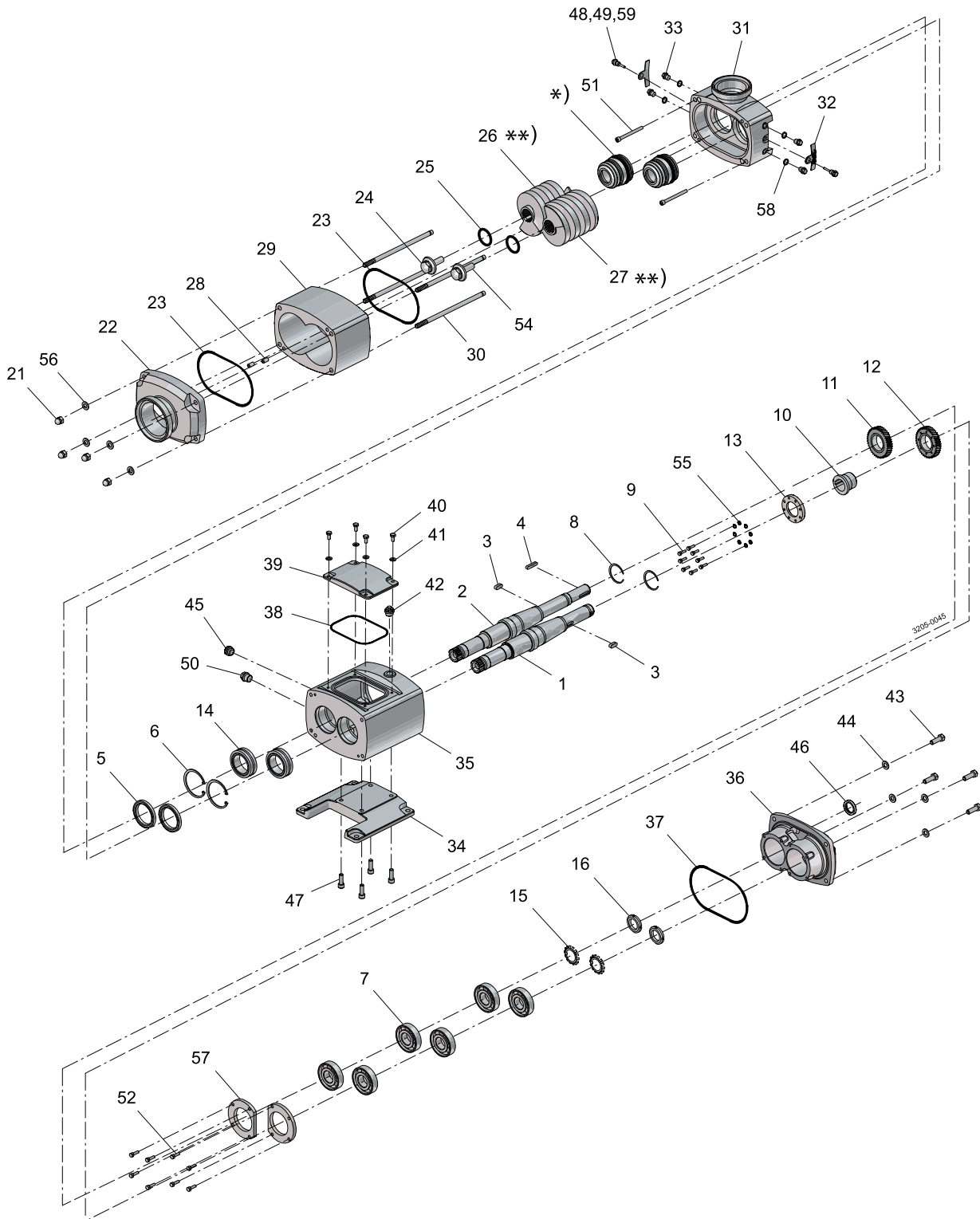

* Cartridge Seal
 ** When replacing Feed Screw it is recommended to replace both Left and Right version

Pos	Qty	Denomination	Item no.	Item no.	Item no.
			OS32	OS34	OS36
35	1	Gearbox	9650303501	9650303501	9650303501
36	1	Gearbox End Cover	9650303601	9650303601	9650303601
37 ^Δ	1	Gearbox End Cover O-Ring	9650303701	9650303701	9650303701
38 ^Δ	1	Gearbox Top Cover O-Ring	9650203701	9650203701	9650203701
39	1	Gearbox Top Cover	9650303901	9650303901	9650303901
40	4	Gearbox Top Cover Bolts	9650004001	9650004001	9650004001
41	4	Gearbox Top Cover Washers	9650004101	9650004101	9650004101
42	1	Filler Plug	9650004201	9650004201	9650004201
43	4	Gearbox End Cover Bolts	9650304301	9650304301	9650304301
44	4	Gearbox End Cover Washers	9650304401	9650304401	9650304401
45	1	Sight Glass	9650004501	9650004501	9650004501
46 ^Δ	1	Rear Lip Seal	9650304601	9650304601	9650304601
47	4	Gearbox Foot Screw	9650304701	9650304701	9650304701
48	2	Gland Guard Plug	9650004801	9650004801	9650004801
49	2	Seal Pin	9650304901	9650304901	9650304901
50	1	Seal Ring	9650005001	9650005001	9650005001
51	2	Cap Screw	9650305101	9650305101	9650305101
52	8	Hex Bolt	9650305201	9650305201	9650305201
54	2	Stud Bolt	9650305401	9650305401	9650305401
55	1	Washer	9650305501	9650305501	9650305501
56	4	Washer	9650304401	9650304401	9650304401
57	2	Bearing Retainer	9650305701	9650305701	9650305701
58	4	Washer Seal Ring	9650005801	9650005801	9650005801
59 [▲]	2	Gland Guard Screw O Ring, FPM	9650005901	9650005901	9650005901
60	2	Heating Pipe Union, - Not Shown	9650306001	9650306001	9650306001
61	2	Heating Pipe Elbow, - Not Shown	9650306101	9650306101	9650306101
62	1	Heating Pipe, - Not Shown	9650306201	9650306201	9650306201

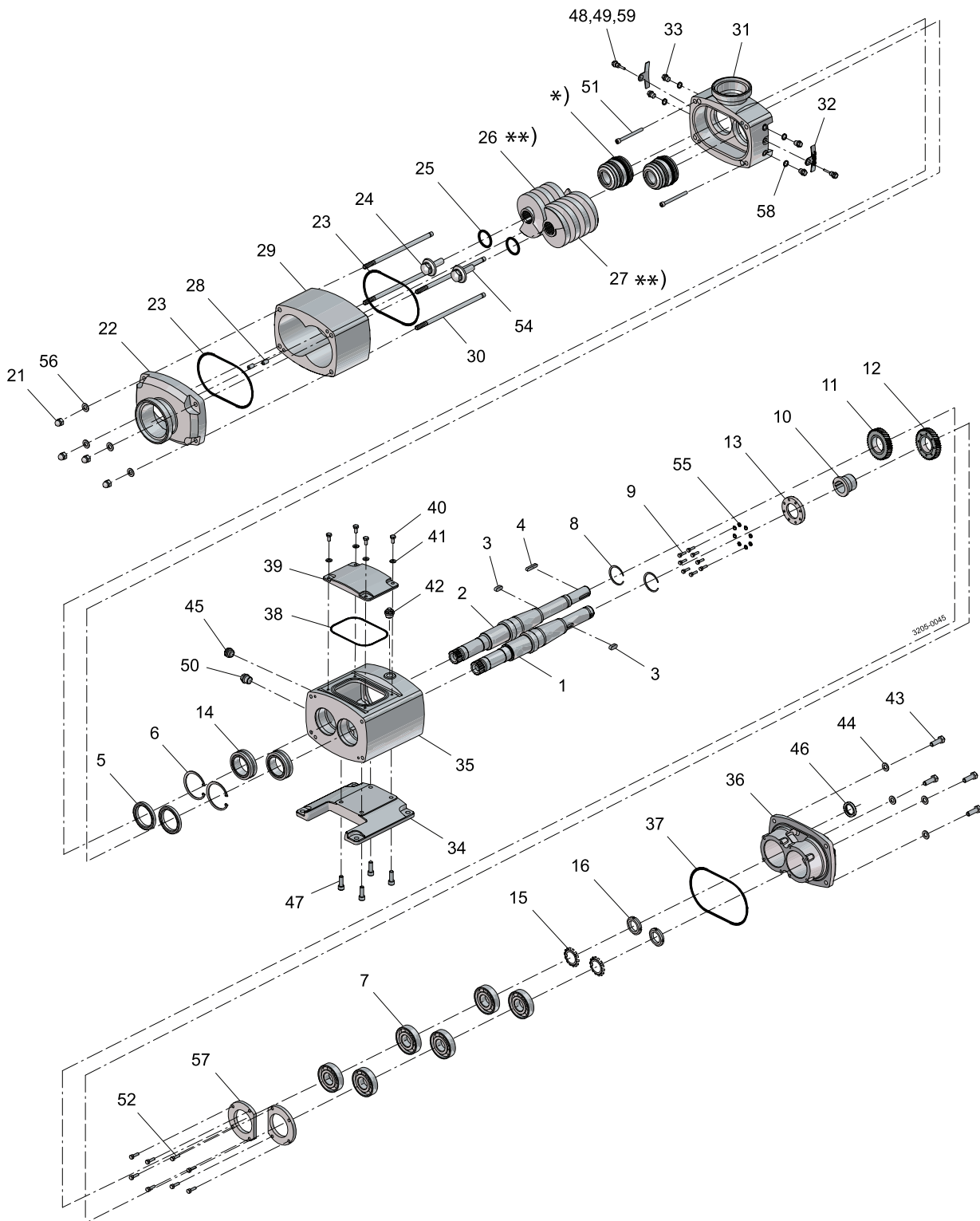

*** Cartridge Seal**
**** When replacing Feed Screw it is recommended to replace both Left and Right version**

Pos	Qty	Denomination	Item no.	Item no.	Item no.
			OS42	OS44	OS46
1	1	Auxiliary Shaft	9650400101	9650400101	9650400101
2	1	Drive Shaft	9650400201	9650400201	9650400201
3	1	Gear Key	9650400301	9650400301	9650400301
4	1	Drive Shaft Key	9650400401	9650400401	9650400401
5	2	Front Lip Seal	9650400501	9650400501	9650400501
6	2	Circlip	9650400601	9650400601	9650400601
7	6	Ball Bearing	9650400701	9650400701	9650400701
8	2	Circlip	9650400801	9650400801	9650400801
9	8	Gear Sleeve Bolts	9650400901	9650400901	9650400901
10	1	Gear Sleeve	9650401001	9650401001	9650401001
11	1	Timing Gear Drive Shaft	9650401101	9650401101	9650401101
12	1	Timing Gear Auxilliary Shaft	9650401201	9650401201	9650401201
13	1	Timing Gear Clamp Plate	9650401301	9650401301	9650401301
14	2	Needle Bearing	9650401401	9650401401	9650401401
15	2	Tab Washer	9650401501	9650401501	9650401501
16	2	Bearing Nut	9650401601	9650401601	9650401601
21	4	Pump Cover Nuts	9650402101	9650402101	9650402101
22	1	Pump Cover, DIN11851 150mm	9650402201	9650402201	9650402201
	1	Pump Cover, DIN11851 100mm	9650402202	9650402202	9650402202
	1	Pump Cover, Tri-Clamp 150mm	9650402203	9650402203	9650402203
	1	Pump Cover, Tri-Clamp 100mm	9650402204	9650402204	9650402204
	1	Pump Cover, RJT 100mm	9650402205	9650402205	9650402205
	1	Pump Cover, SMS 100mm	9650402206	9650402206	9650402206
	1	Pump Cover, IDF 100mm	9650402207	9650402207	9650402207
	1	Pump Cover, DIN11864-1-A 100mm	9650402208	9650402208	9650402208
	1	Pump Cover, DIN11864-1-C 100mm	9650402209	9650402209	9650402209
	1	Pump Cover, DIN11864-2-A 150mm	9650402210	9650402210	9650402210
	1	Pump Cover, DIN11864-2-A 100mm	9650402211	9650402211	9650402211
	1	Pump Cover, DIN11864-2-C 100mm	9650402212	9650402212	9650402212
	1	Pump Cover, Rectangular	9650402299	9650402299	9650402299
23	2	Pump Casing Elastomer, EPDM	9650402301	9650402301	9650402301
	2	Pump Casing Elastomer, FPM	9650402302	9650402302	9650402302
	2	Pump Casing Elastomer, FFPM	9650402303	9650402303	9650402303
24	2	Feed Screw Nut	9650402401	9650402401	9650402401
25	2	Feed Screw Elastomer, EPDM	9650402501	9650402501	9650402501
	2	Feed Screw Elastomer, FPM	9650402502	9650402502	9650402502
	2	Feed Screw Elastomer, FFPM	9650402503	9650402503	9650402503
26	1	Feed Screw, Left Standard	9650422601	9650442601	9650462601
	1	Feed Screw, Left Hardened	9650422602	9650442602	9650462602
27	1	Feed Screw, Right Standard	9650422701	9650442701	9650462701
	1	Feed Screw, Right Hardened	9650422702	9650442702	9650462702
28	6	Pump Casing, Dowels	9650002801	9650002801	9650002801
29	1	Pump Casing	9650402901	9650402901	9650402901
	1	Pump Casing, Hardened For Heating Jacket	9650402903	9650402903	9650402903
30	4	Pump Casing, Studs	9650403001	9650403001	9650403001
31	1	Seal Housing, DIN11851 100mm	9650403101	9650403101	9650403101
	1	Seal Housing, DIN11851 80mm	9650403102	9650403102	9650403102
	1	Seal Housing, Tri-Clamp 100mm	9650403103	9650403103	9650403103
	1	Seal Housing, Tri-Clamp 80mm	9650403104	9650403104	9650403104
	1	Seal Housing, RJT 100mm	9650403105	9650403105	9650403105
	1	Seal Housing, RJT 80mm	9650403106	9650403106	9650403106
	1	Seal Housing, SMS 100mm	9650403107	9650403107	9650403107
	1	Seal Housing, SMS 80mm	9650403108	9650403108	9650403108
	1	Seal Housing, IDF 100mm	9650403109	9650403109	9650403109
	1	Seal Housing, IDF 80mm	9650403110	9650403110	9650403110
	1	Seal Housing, DIN11864-1-A 100mm	9650403111	9650403111	9650403111
	1	Seal Housing, DIN11864-1-A 80mm	9650403112	9650403112	9650403112
	1	Seal Housing, DIN11864-1-C 100mm	9650403113	9650403113	9650403113
	1	Seal Housing, DIN11864-1-C 80mm	9650403114	9650403114	9650403114
	1	Seal Housing, DIN11864-2-A 100mm	9650403115	9650403115	9650403115
	1	Seal Housing, DIN11864-2-C 100mm	9650403116	9650403116	9650403116
	1	Seal Housing, DIN11864-2-A 80mm	9650403117	9650403117	9650403117
	1	Seal Housing, DIN11864-2-C 80mm	9650403118	9650403118	9650403118
32	2	Gland Guard	9650403201	9650403201	9650403201
33	4	Flush Plugs	9650403301	9650403301	9650403301
	4	Flush Caps	9650403302	9650403302	9650403302
34	1	Foot	9650403401	9650403401	9650403401
35	1	Gearbox	9650403501	9650403501	9650403501
36	1	Gearbox End Cover	9650403601	9650403601	9650403601
37	1	Gearbox End Cover O-Ring	9650403701	9650403701	9650403701
38	1	Gearbox Top Cover O-Ring	9650303701	9650303701	9650303701
39	1	Gearbox Top Cover	9650403901	9650403901	9650403901
40	4	Gearbox Top Cover Bolts	9650004001	9650004001	9650004001
41	4	Gearbox Top Cover Washers	9650004101	9650004101	9650004101
42	1	Filler Plug	9650004201	9650004201	9650004201
43	4	Gearbox End Cover Bolts	9650404301	9650404301	9650404301
44	4	Gearbox End Cover Washers	9650404401	9650404401	9650404401

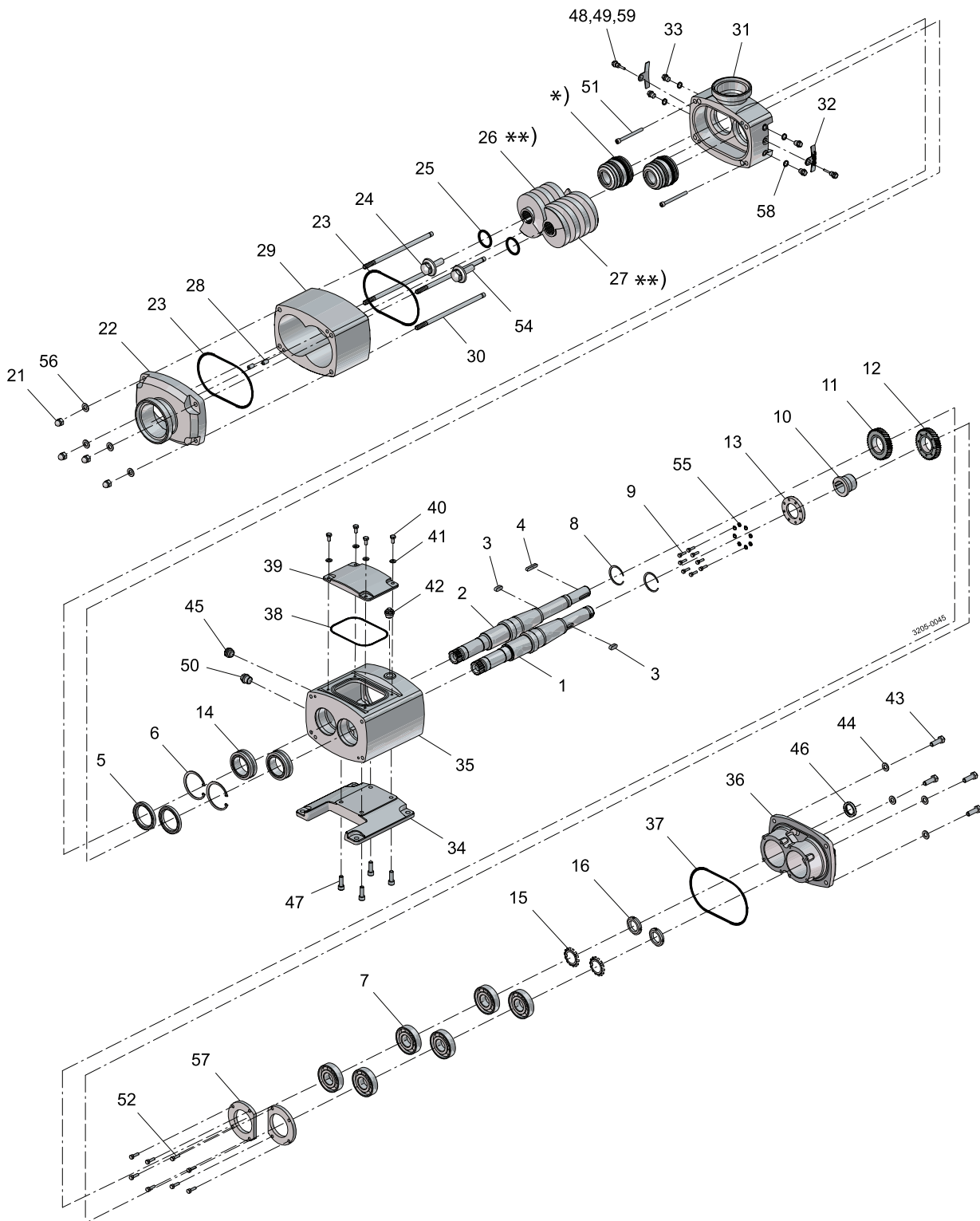

*** Cartridge Seal**
**** When replacing Feed Screw it is recommended to replace both Left and Right version**

Pos	Qty	Denomination	Item no.	Item no.	Item no.
			OS42	OS44	OS46
45	1	Sight Glass	9650004501	9650004501	9650004501
46 ^Δ	1	Rear Lip Seal	9650404601	9650404601	9650404601
47	4	Gearbox Foot Screw	9650404701	9650404701	9650404701
48	2	Gland Guard Plug	9650004801	9650004801	9650004801
49	2	Seal Pin	9650404901	9650404901	9650404901
50	1	Washer Gearbox Plug	9650005001	9650005001	9650005001
51	2	Cap Screw	9650405101	9650405101	9650405101
52	8	Hex Bolt	9650405201	9650405201	9650405201
54	2	Stud Bolt	9650405401	9650405401	9650405401
55	1	Washer	9650405501	9650405501	9650405501
56	4	Washer	9650404401	9650404401	9650404401
57	2	Bearing Retainer	9650405701	9650405701	9650405701
58	4	Washer Seal Ring	9650005801	9650005801	9650005801
59 [▲]	4	Gland Guard Screw O Ring, FPM	9650005901	9650005901	9650005901
60	2	Heating Pipe Union, - Not Shown	9650406001	9650406001	9650406001
61	2	Heating Pipe Elbow, - Not Shown	9650406101	9650406101	9650406101
62	1	Heating Pipe, - Not Shown	9650406201	9650406201	9650406201
63	2	Heating Adapter, - Not Shown	9650406301	9650406301	9650406301

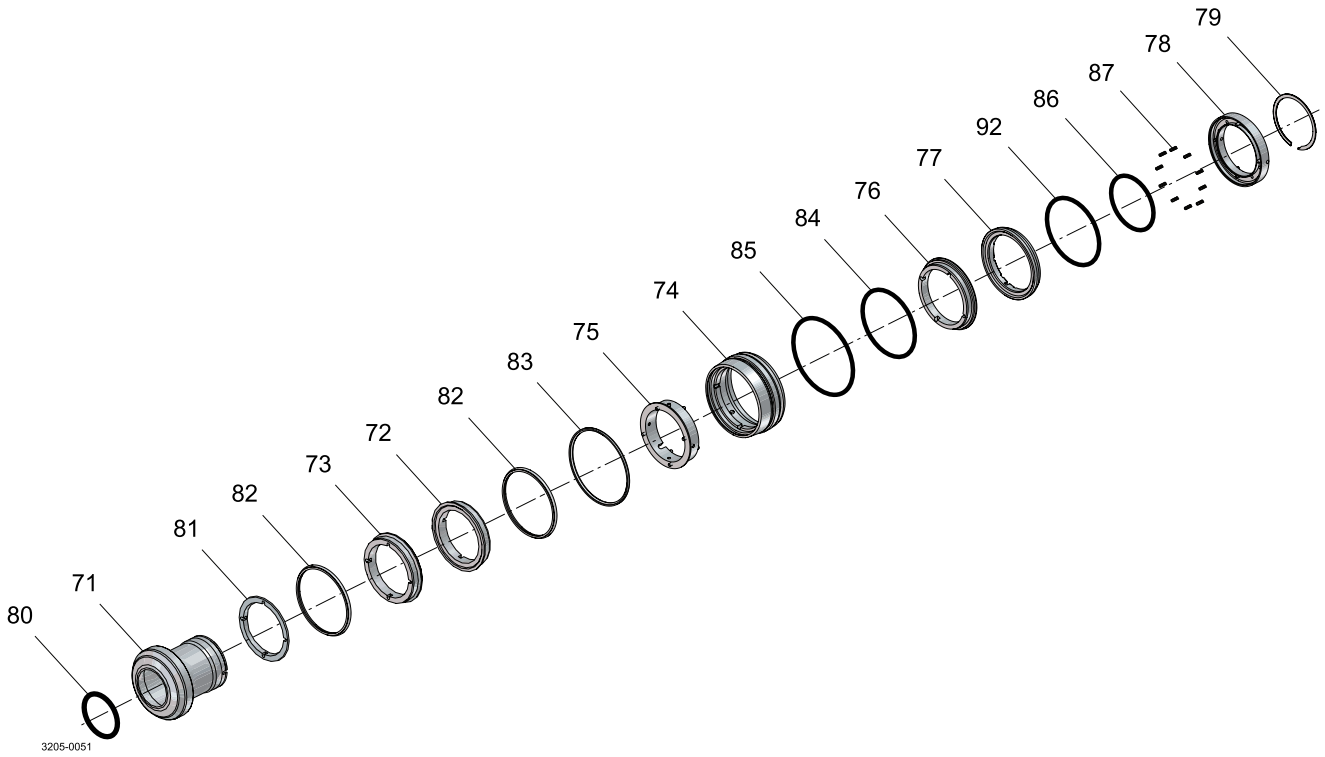

Pos	Qty	Denomination	OS12/14/16	OS22/24/26	OS32/34/36	OS42/44/46
Quantities shown are for complete pump (2 pcs complete seal per pump). Quantities shown may vary depending on seal type and materials fitted						
71	2	Sleeve / Holder, Single Rotary Holder, FPM	9650107102	9650207102	9650307102	9650407102
	2	Sleeve / Holder, Double Rotary Holder, EPDM		9650207103	9650307103	9650407103
	2	Sleeve / Holder, Double Rotary Holder, FPM		9650207104	9650307104	9650407104
	2	Sleeve / Holder, Double Rotary Holder, FFPM		9650207105	9650307105	9650407105
72	□○✦	2 Seal Face, SC	9650107301	9650207301	9650307301	9650407301
	2	Seal Face, Carbon	9650107302	9650207302	9650307302	9650407302
	2	Seal Face, TC	9650107303	9650207303	9650307303	9650407303
73	□○✦	2 Seal Face, SC	9650107301	9650207301	9650307301	9650407301
	2	Seal Face, Carbon	9650107303	9650207303	9650307303	9650407303
	2	Seal Face, TC	9650107303	9650207303	9650307303	9650407303
74	2	Housing Double	9650107401	9650207401	9650307401	9650407401
75	2	Drive Ring Inner Assy	9650107501	9650207501	9650307501	9650407501
76	○	2 Static Face Double	9650107601	9650207601	9650307601	9650407601
77	○	2 Rotary Face Double	9650107701	9650207701	9650307701	9650407701
78	2	Drive Ring Outer Assy		9650207801	9650307801	9650407801
79	○	2 Circlip Double Housing		9650207901	9650307901	9650407901
80	□○✦	2 P Ring, EPDM	9650208001	9650208001	9650308001	9650408001
	2	P Ring, FPM	9650208002	9650208002	9650308002	9650408002
	2	P Ring, FFPM	9650208003	9650208003	9650308003	9650408003
81	□○✦	2 Washer, PTFE	9650108101	9650208101	9650308101	9650408101
82	□○✦	2 P Ring, EPDM	9650108201	9650208201	9650308201	9650408201
	2	P Ring, FPM	9650108202	9650208202	9650308202	9650408202
	2	P Ring, FFPM	9650108203	9650208203	9650308203	9650408203
83	□○✦	2 P Ring, EPDM	9650108301	9650208301	9650308301	9650408301
	2	P Ring, FPM	9650108301	9650208302	9650308302	9650408302
	2	P Ring, FFPM	9650108302	9650208303	9650308303	9650408303
84	○	2 O Ring, EPDM	9630023531	9650208401	9650308401	9650408401
	2	O Ring, FPM	9630023418	9650208402	9650308402	9650408402
	2	O Ring, FFPM	9630668559	9650208403	9650308403	9650408403
85	○✦	2 O Ring, EPDM	9630075999	9650208501	9650308501	9650408501
	2	O Ring, FPM	9630075998	9650208502	9650308502	9650408502
	2	O Ring, FFPM	9630685072	9650208503	9650308503	9650408503
86	○	2 O Ring, EPDM	9630046190	9650208601	9650208401	9650408601
	2	O Ring, FPM	9630046189	9650208602	9650208402	9650408602
	2	O Ring, FFPM	9630668403	9650208603	9650208403	9650408603
87	□○✦	16 Coil Spring	9650108701			
	□○✦	20 Coil Spring		9650208701	9650308701	
	□○✦	32 Coil Spring				9650408701
88	2	Housing Assy Single	9650108801	9650208801	9650308801	9650408801
89	□○✦	2 Circlip Single Housing	9650108901	9650208901	9650308901	9650408901
90	✦	2 Lip Seal Flush FPM	9650109001	9650209001	9650309001	9650409001
91	✦	2 Circlip Lip Seal Flush	9650109101	9650209101	9650309101	9650409101
92	○	2 O Ring, EPDM	9630023531	9650209201	9650308401	9650408401
	2	O Ring, FPM	9630023418	9650209202	9650308402	9650408402
	2	O Ring, FFPM	9630668559	9650209203	9650308403	9650408403
93	2	Drive Ring, Double Outer/ Sleeve	9650107801			
94	2	Rotary Holder Double	9650107103			

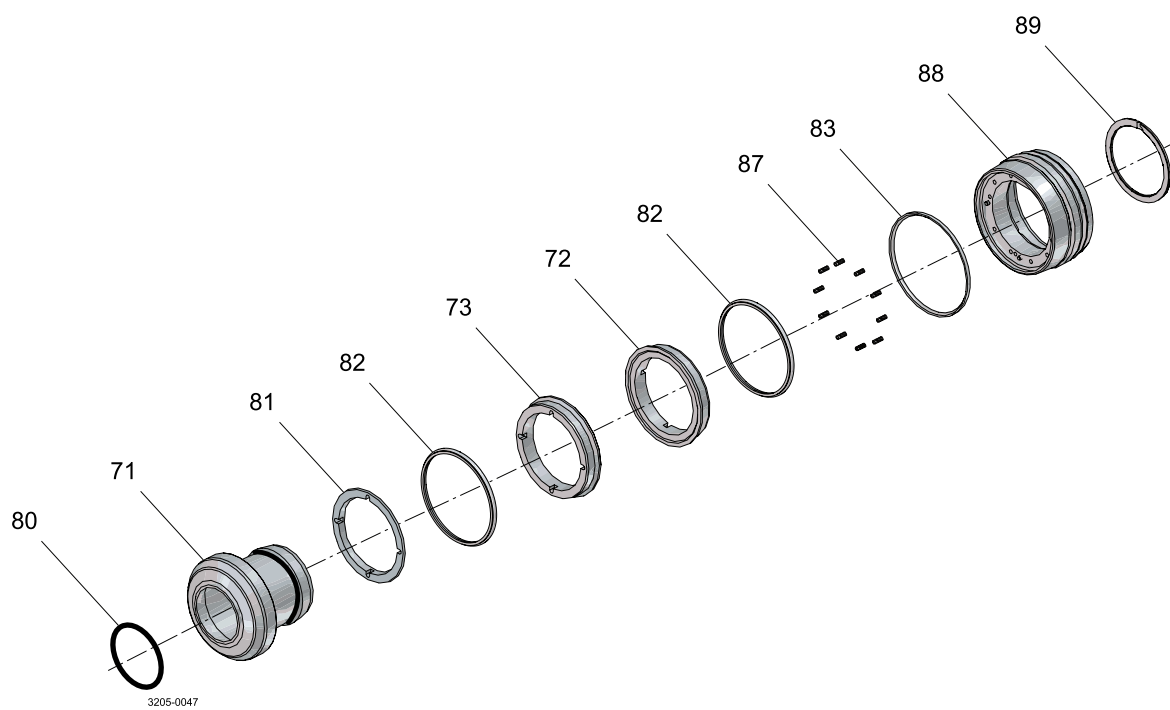

Twin Screw Pump Range – Single Seal

Pos	Qty Denomination	OS12/14/16 EPDM	OS22/24/26 EPDM	OS32/34/36 EPDM	OS42/44/46 EPDM
For servicing complete pump, 2 pcs. complete seals are required					
▪	Complete Single Seal SC/C EPDM:	9650109501	9650209501	9650309501	9650409501
71	1 ROTARY HOLDER SINGLE				
72	1 STATIC FACE CARBON				
73	1 STATIC/ROTARY FACE SC				
80	1 P RING EPDM				
81	1 WASHER PTFE				
82	1 P RING EPDM				
83	1 P RING EPDM				
87	8 COIL SPRING (OS12/14/16)				
	10 COIL SPRING (OS22/24/26/32/34/36)				
	16 COIL SPRING (OS42/44/46)				
88	1 HOUSING ASSY SINGLE				
89	1 CIRCLIP SINGLE HOUSING				

Pos	Qty Denomination	OS12/14/16 FPM	OS22/24/26 FPM	OS32/34/36 FPM	OS42/44/46 FPM
▪	Complete Single Seal SC/C FPM:	9650109502	9650209502	9650309502	9650409502
71	1 ROTARY HOLDER SINGLE				
72	1 STATIC FACE CARBON				
73	1 STATIC/ROTARY FACE SC				
80	1 P RING FPM				
81	1 WASHER PTFE				
82	1 P RING FPM				
83	1 P RING FPM				
87	8 COIL SPRING (OS12/14/16)				
	10 COIL SPRING (OS22/24/26/32/34/36)				
	16 COIL SPRING (OS42/44/46)				
88	1 HOUSING ASSY SINGLE				
89	1 CIRCLIP SINGLE HOUSING				

Pos	Qty Denomination	OS12/14/16 FFPM	OS22/24/26 FFPM	OS32/34/36 FFPM	OS42/44/46 FFPM
▪	Complete Single Seal SC/C FFPM:	9650109503	9650209503	9650309503	9650409503
71	1 ROTARY HOLDER SINGLE				
72	1 STATIC FACE CARBON				
73	1 STATIC/ROTARY FACE SC				
80	1 P RING FFPM				
81	1 WASHER PTFE				
82	1 P RING FFPM				
83	1 P RING FFPM				
87	8 COIL SPRING (OS12/14/16)				
	10 COIL SPRING (OS22/24/26/32/34/36)				
	16 COIL SPRING (OS42/44/46)				
88	1 HOUSING ASSY SINGLE				
89	1 CIRCLIP SINGLE HOUSING				

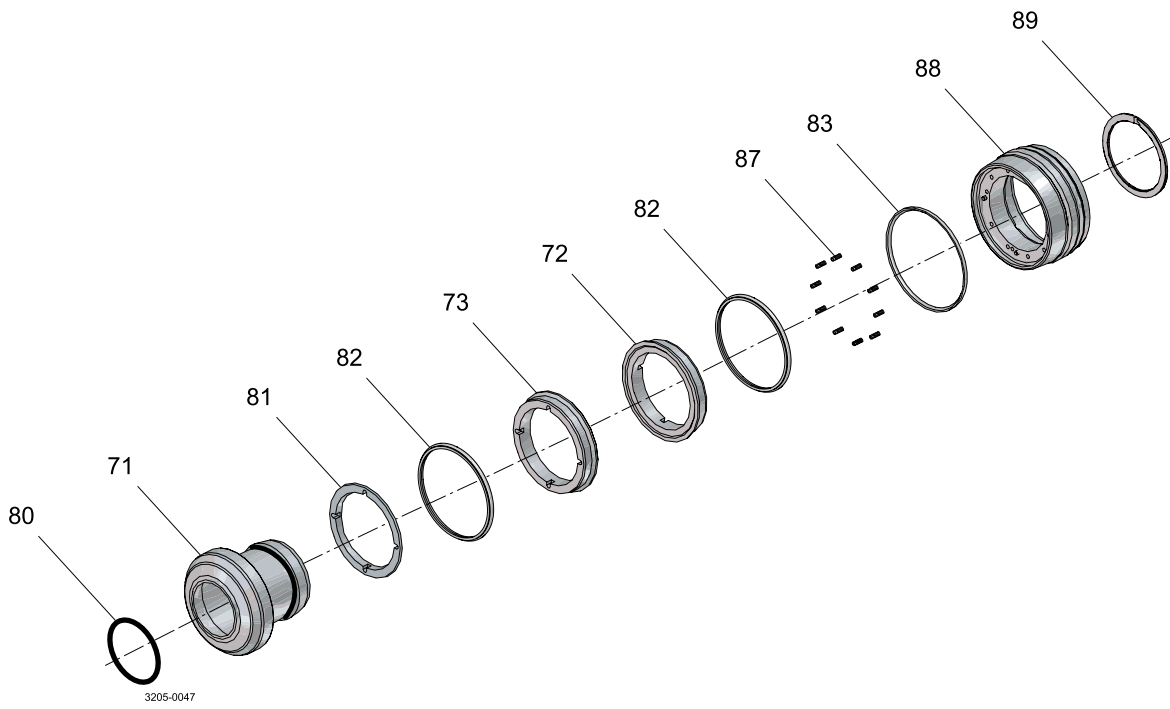

Twin Screw Pump Range – Single Seal

Pos	Qty	Denomination	OS12/14/16 EPDM	OS22/24/26 EPDM	OS32/34/36 EPDM	OS42/44/46 EPDM
For servicing complete pump, 2 pcs. complete seals are required						
	■	Complete Single Seal SC/SC EPDM:	9650109511	9650209511	9650309511	9650409511
71	1	ROTARY HOLDER SINGLE				
72	1	STATIC FACE SC				
73	1	STATIC/ROTARY FACE SC				
80	1	P RING EPDM				
81	1	WASHER PTFE				
82	1	P RING EPDM				
83	1	P RING EPDM				
87	8	COIL SPRING (OS12/14/16)				
	10	COIL SPRING (OS22/24/26/32/34/36)				
	16	COIL SPRING (OS42/44/46)				
88	1	HOUSING ASSY SINGLE				
89	1	CIRCLIP SINGLE HOUSING				

Pos	Qty	Denomination	OS12/14/16 FPM	OS22/24/26 FPM	OS32/34/36 FPM	OS42/44/46 FPM
	■	Complete Single Seal SC/SC FPM:	9650109512	9650209512	9650309512	9650409512
71	1	ROTARY HOLDER SINGLE				
72	1	STATIC FACE SC				
73	1	STATIC/ROTARY FACE SC				
80	1	P RING FPM				
81	1	WASHER PTFE				
82	1	P RING FPM				
83	1	P RING FPM				
87	8	COIL SPRING (OS12/14/16)				
	10	COIL SPRING (OS22/24/26/32/34/36)				
	16	COIL SPRING (OS42/44/46)				
88	1	HOUSING ASSY SINGLE				
89	1	CIRCLIP SINGLE HOUSING				

Pos	Qty	Denomination	OS12/14/16 FFPM	OS22/24/26 FFPM	OS32/34/36 FFPM	OS42/44/46 FFPM
	■	Complete Single Seal SC/SC FFPM:	9650109513	9650209513	9650309513	9650409513
71	1	ROTARY HOLDER SINGLE				
72	1	STATIC FACE SC				
73	1	STATIC/ROTARY FACE SC				
80	1	P RING FFPM				
81	1	WASHER PTFE				
82	1	P RING FFPM				
83	1	P RING FFPM				
87	8	COIL SPRING (OS12/14/16)				
	10	COIL SPRING (OS22/24/26/32/34/36)				
	16	COIL SPRING (OS42/44/46)				
88	1	HOUSING ASSY SINGLE				
89	1	CIRCLIP SINGLE HOUSING				

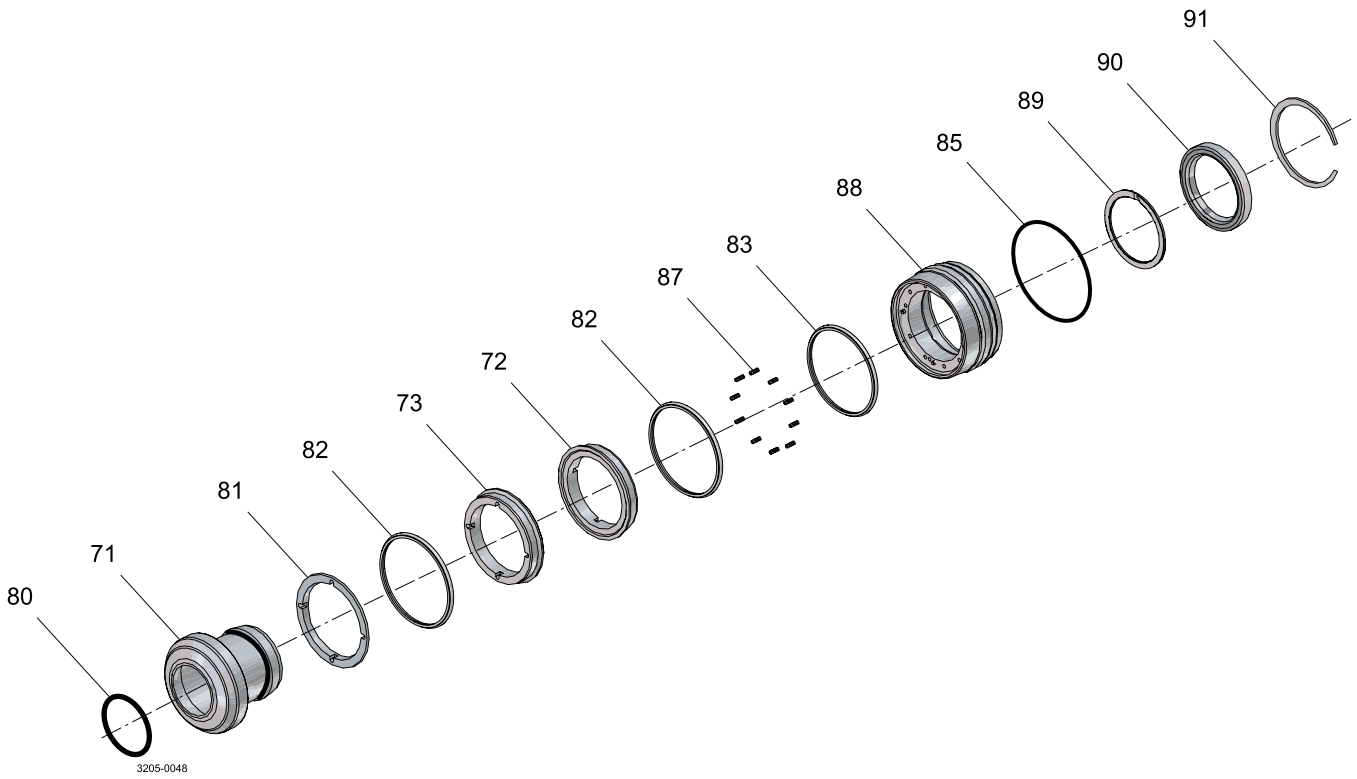

Twin Screw Pump Range – Single Flushed Seal

Pos	Qty	Denomination	OS12/14/16 EPDM	OS22/24/26 EPDM	OS32/34/36 EPDM	OS42/44/46 EPDM
For servicing complete pump, 2 pcs. complete seals are required						
♦		Complete Single Flushed Seal SC/C EPDM:	9650109551	9650209551	9650309551	9650409551
71	1	ROTARY HOLDER SINGLE				
72	1	STATIC FACE CARBON				
73	1	STATIC/ROTARY FACE SC				
80	1	P RING EPDM				
81	1	WASHER PTFE				
82	1	P RING EPDM				
83	1	P RING EPDM				
85	1	O RING EPDM				
87	8	COIL SPRING (OS12/14/16)				
	10	COIL SPRING (OS22/24/26/32/34/36)				
	16	COIL SPRING (OS42/44/46)				
88	1	HOUSING ASSY SINGLE				
89	1	CIRCLIP SINGLE HOUSING				
90	1	LIP SEAL FLUSH FPM				
91	1	CIRCLIP LIP SEAL FLUSH				

Pos	Qty	Denomination	OS12/14/16 FPM	OS22/24/26 FPM	OS32/34/36 FPM	OS42/44/46 FPM
♦		Complete Single Flushed Seal SC/C FPM:	9650109552	9650209552	9650309552	9650409552
71	1	ROTARY HOLDER SINGLE				
72	1	STATIC FACE CARBON				
73	1	STATIC/ROTARY FACE SC				
80	1	P RING FPM				
81	1	WASHER PTFE				
82	1	P RING FPM				
83	1	P RING FPM				
85	1	O RING FPM				
87	8	COIL SPRING (OS12/14/16)				
	10	COIL SPRING (OS22/24/26/32/34/36)				
	16	COIL SPRING (OS42/44/46)				
88	1	HOUSING ASSY SINGLE				
89	1	CIRCLIP SINGLE HOUSING				
90	1	LIP SEAL FLUSH FPM				
91	1	CIRCLIP LIP SEAL FLUSH				

Pos	Qty	Denomination	OS12/14/16 FFPM	OS22/24/26 FFPM	OS32/34/36 FFPM	OS42/44/46 FFPM
♦		Complete Single Flushed Seal SC/C FFPM:	9650109553	9650209553	9650309553	9650409553
71	1	ROTARY HOLDER SINGLE				
72	1	STATIC FACE CARBON				
73	1	STATIC/ROTARY FACE SC				
80	1	P RING FFPM				
81	1	WASHER PTFE				
82	1	P RING FFPM				
83	1	P RING FFPM				
85	1	O RING FFPM				
87	8	COIL SPRING (OS12/14/16)				
	10	COIL SPRING (OS22/24/26/32/34/36)				
	16	COIL SPRING (OS42/44/46)				
88	1	HOUSING ASSY SINGLE				
89	1	CIRCLIP SINGLE HOUSING				
90	1	LIP SEAL FLUSH FPM				
91	1	CIRCLIP LIP SEAL FLUSH				

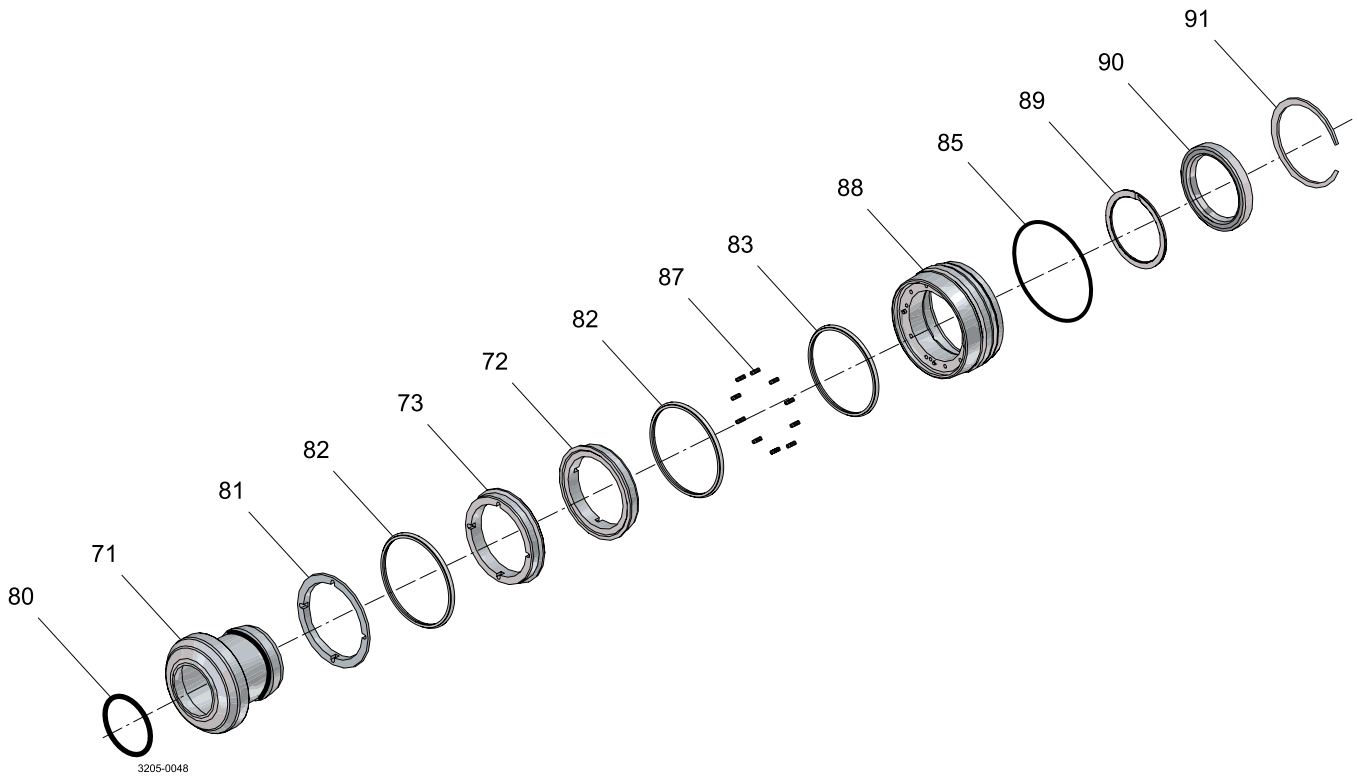

Twin Screw Pump Range – Single Flushed Seal

Pos	Qty	Denomination	OS12/14/16 EPDM	OS22/24/26 EPDM	OS32/34/36 EPDM	OS42/44/46 EPDM
For servicing complete pump, 2 pcs. complete seals are required						
♦		Complete Single Flushed Seal SC/SC EPDM:	9650109561	9650209561	9650309561	9650409561
71	1	ROTARY HOLDER SINGLE				
72	1	STATIC FACE SC				
73	1	STATIC/ROTARY FACE SC				
80	1	P RING EPDM				
81	1	WASHER PTFE				
82	1	P RING EPDM				
83	1	P RING EPDM				
85	1	O RING EPDM				
87	8	COIL SPRING (OS12/14/16)				
	10	COIL SPRING (OS22/24/26/32/34/36)				
	16	COIL SPRING (OS42/44/46)				
88	1	HOUSING ASSY SINGLE				
89	1	CIRCLIP SINGLE HOUSING				
90	1	LIP SEAL FLUSH FPM				
91	1	CIRCLIP LIP SEAL FLUSH				

Pos	Qty	Denomination	OS12/14/16 FPM	OS22/24/26 FPM	OS32/34/36 FPM	OS42/44/46 FPM
♦		Complete Single Flushed Seal SC/SC FPM:	9650109562	9650209562	9650309562	9650409562
71	1	ROTARY HOLDER SINGLE				
72	1	STATIC FACE SC				
73	1	STATIC/ROTARY FACE SC				
80	1	P RING FPM				
81	1	WASHER PTFE				
82	1	P RING FPM				
83	1	P RING FPM				
85	1	O RING FPM				
87	8	COIL SPRING (OS12/14/16)				
	10	COIL SPRING (OS22/24/26/32/34/36)				
	16	COIL SPRING (OS42/44/46)				
88	1	HOUSING ASSY SINGLE				
89	1	CIRCLIP SINGLE HOUSING				
90	1	LIP SEAL FLUSH FPM				
91	1	CIRCLIP LIP SEAL FLUSH				

Pos	Qty	Denomination	OS12/14/16 FFPM	OS22/24/26 FFPM	OS32/34/36 FFPM	OS42/44/46 FFPM
♦		Complete Single Flushed Seal SC/SC FFPM:	9650109563	9650209563	9650309563	9650409563
71	1	ROTARY HOLDER SINGLE				
72	1	STATIC FACE SC				
73	1	STATIC/ROTARY FACE SC				
80	1	P RING FFPM				
81	1	WASHER PTFE				
82	1	P RING FFPM				
83	1	P RING FFPM				
85	1	O RING FFPM				
87	8	COIL SPRING (OS12/14/16)				
	10	COIL SPRING (OS22/24/26/32/34/36)				
	16	COIL SPRING (OS42/44/46)				
88	1	HOUSING ASSY SINGLE				
89	1	CIRCLIP SINGLE HOUSING				
90	1	LIP SEAL FLUSH FPM				
91	1	CIRCLIP LIP SEAL FLUSH				

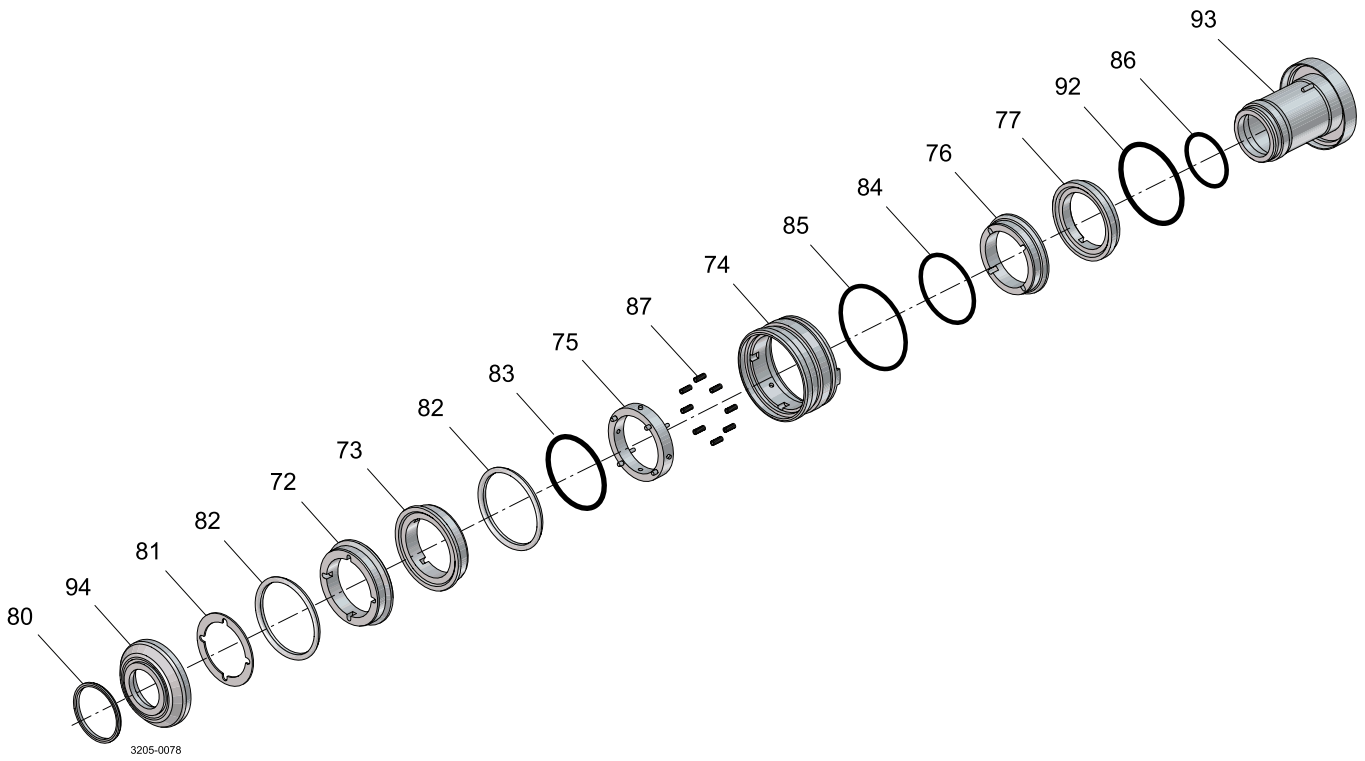

OS 10 Double Seal

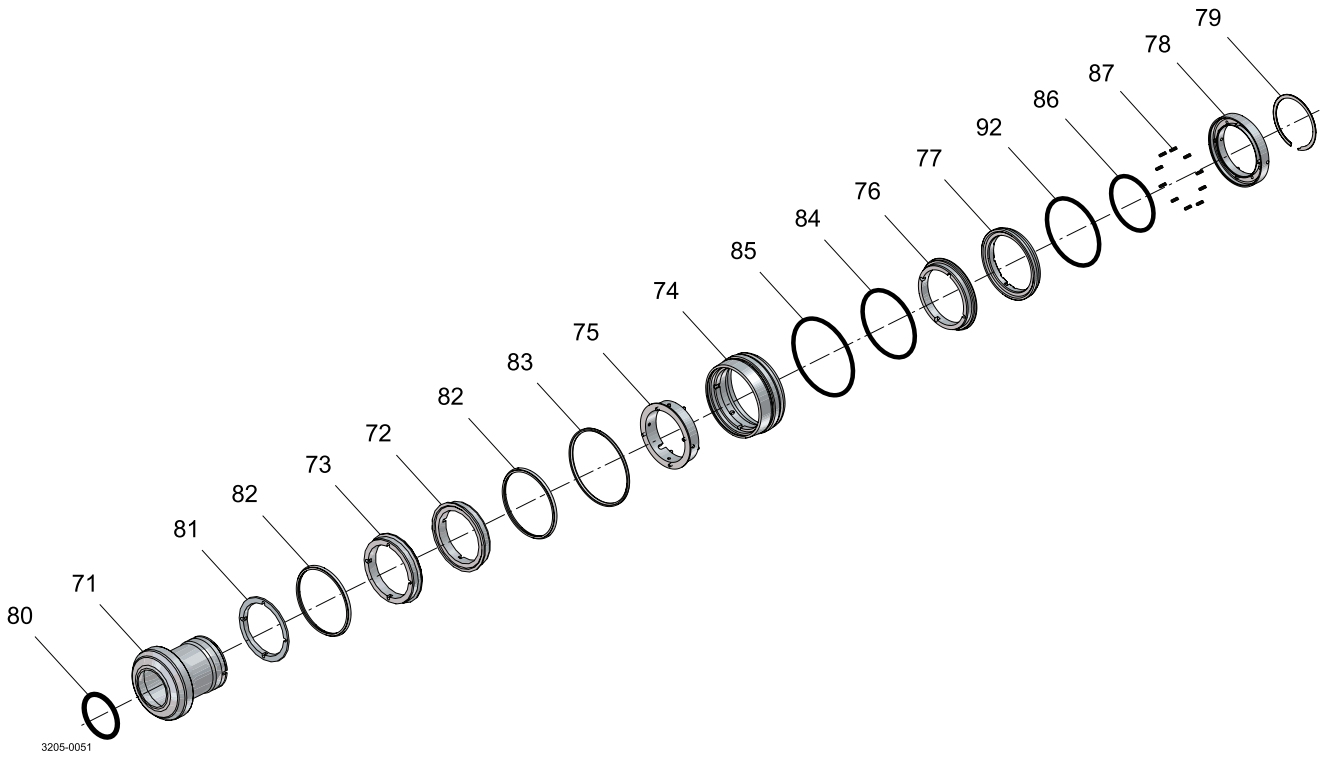

OS 20 / 30 / 40 Double Seal

Twin Screw Pump Range – Double Seal

Pos	Qty	Denomination	OS12/14/16 EPDM	OS22/24/26 EPDM	OS32/34/36 EPDM	OS42/44/46 EPDM
For servicing complete pump, 2 pcs. complete seals are required						
	•	Complete Double Seal SC/C/SC/C EPDM:	9650109571	9650209571	9650309571	9650409571
71	1	ROTARY HOLDER DBL EPDM				
72	1	STATIC FACE CARBON				
73	1	STATIC/ROTARY FACE SC				
74	1	HOUSING DOUBLE				
75	1	DRIVE RING ASSY INNER DBL				
76	1	STATIC FACE DOUBLE SC				
77	1	ROTARY FACE DOUBLE CARBON				
78	1	DRIVE RING ASSY OUTER DBL				
79	1	CIRCLIP DOUBLE HOUSING				
80	1	P RING EPDM				
81	1	WASHER PTFE				
82	1	P RING EPDM				
83	1	P RING EPDM				
84	1	O RING EPDM				
85	1	O RING EPDM				
86	1	O RING EPDM				
87	8	COIL SPRING (OS12/14/16)				
	10	COIL SPRING (OS22/24/26/32/34/36)				
	16	COIL SPRING (OS42/44/46)				
92	1	O RING EPDM				
93	1	DRIVE RING, ASSY OUTER DBL / SLEEVE				
94	1	ROTARY HOLDER DBL				

Pos	Qty	Denomination	OS12/14/16 FPM	OS22/24/26 FPM	OS32/34/36 FPM	OS42/44/46 FPM
	•	Complete Double Seal SC/C/SC/C FPM:	9650109572	9650209572	9650309572	9650409572
71	1	ROTARY HOLDER DBL EPDM				
72	1	STATIC FACE CARBON				
73	1	STATIC/ROTARY FACE SC				
74	1	HOUSING DOUBLE				
75	1	DRIVE RING ASSY INNER DBL				
76	1	STATIC FACE DOUBLE SC				
77	1	ROTARY FACE DOUBLE CARBON				
78	1	DRIVE RING ASSY OUTER DBL				
79	1	CIRCLIP DOUBLE HOUSING				
80	1	P RING FPM				
81	1	WASHER PTFE				
82	1	P RING FPM				
83	1	P RING FPM				
84	1	O RING FPM				
85	1	O RING FPM				
87	8	COIL SPRING (OS12/14/16)				
	10	COIL SPRING (OS22/24/26/32/34/36)				
	16	COIL SPRING (OS42/44/46)				
92	1	O RING FPM				
93	1	DRIVE RING, ASSY OUTER DBL / SLEEVE				
94	1	ROTARY HOLDER DBL				

Pos	Qty	Denomination	OS12/14/16 FFPM	OS22/24/26 FFPM	OS32/34/36 FFPM	OS42/44/46 FFPM
	•	Complete Double Seal SC/C/SC/C FFPM:	9650109573	9650209573	9650309573	9650409573
71	1	ROTARY HOLDER DBL EPDM				
72	1	STATIC FACE CARBON				
73	1	STATIC/ROTARY FACE SC				
74	1	HOUSING DOUBLE				
75	1	DRIVE RING ASSY INNER DBL				
76	1	STATIC FACE DOUBLE SC				
77	1	ROTARY FACE DOUBLE CARBON				
78	1	DRIVE RING ASSY OUTER DBL				
79	1	CIRCLIP DOUBLE HOUSING				
80	1	P RING FFPM				
81	1	WASHER PTFE				
82	1	P RING FFPM				
83	1	P RING FFPM				
84	1	O RING FFPM				
85	1	O RING FFPM				
86	1	O RING FFPM				
87	8	COIL SPRING (OS12/14/16)				
	10	COIL SPRING (OS22/24/26/32/34/36)				
	16	COIL SPRING (OS42/44/46)				
92	1	O RING FFPM				
93	1	DRIVE RING, ASSY OUTER DBL / SLEEVE				
94	1	ROTARY HOLDER DBL				

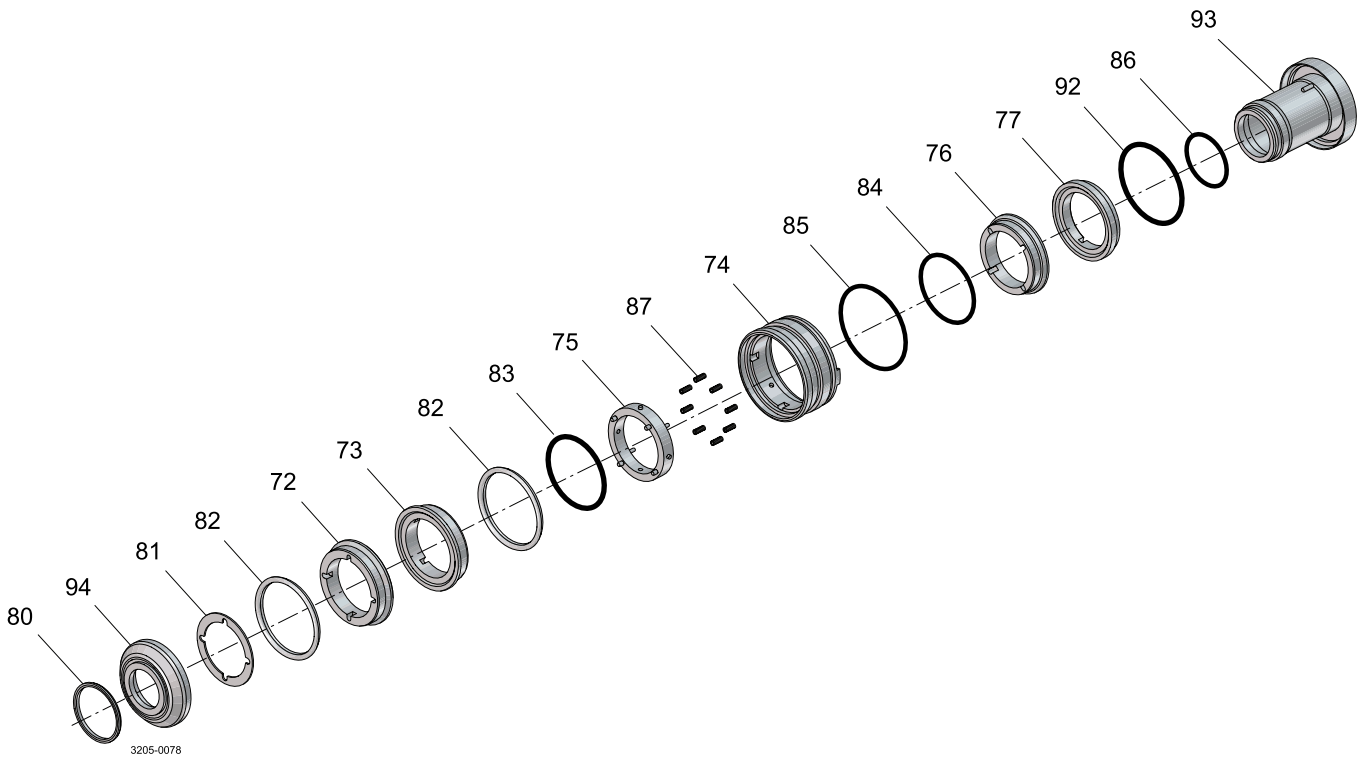

OS 10 Double Seal

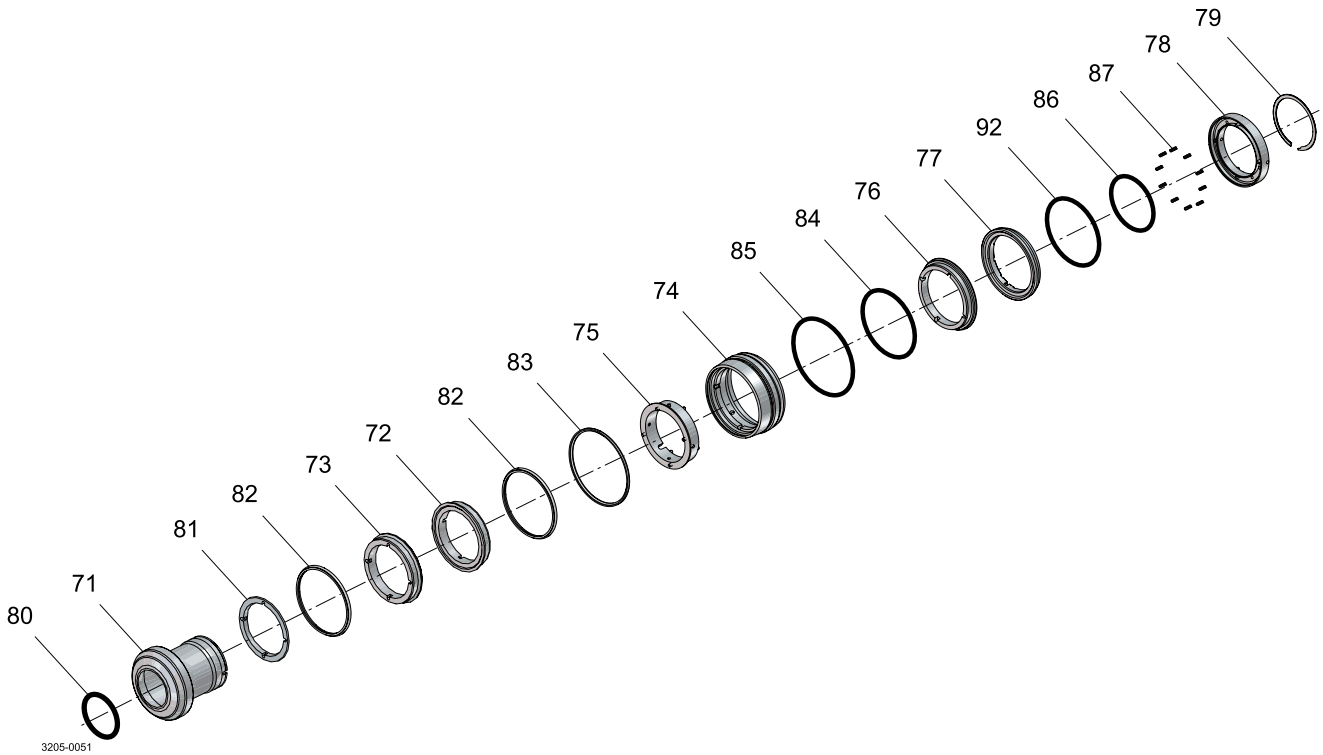

OS 20 / 30 / 40 Double Seal

Twin Screw Pump Range – Double Seal

Pos	Qty	Denomination	OS12/14/16 EPDM	OS22/24/26 EPDM	OS32/34/36 EPDM	OS42/44/46 EPDM
For servicing complete pump, 2 pcs. complete seals are required						
	•	Complete Double Seal SC/SC/SC/C EPDM:	9650109581	9650209581	9650309581	9650409581
71	1	ROTARY HOLDER DBL EPDM				
72	1	STATIC/ROTARY FACE SC				
73	1	STATIC/ROTARY FACE SC				
74	1	HOUSING DOUBLE SS				
75	1	DRIVE RING ASSY INNER DBL				
76	1	STATIC FACE DOUBLE SC				
77	1	ROTARY FACE DOUBLE CARBON				
78	1	DRIVE RING ASSY OUTER DBL				
79	1	CIRCLIP DOUBLE HOUSING				
80	1	P RING EPDM				
81	1	WASHER PTFE				
82	1	P RING EPDM				
83	1	P RING EPDM				
84	1	O RING EPDM				
85	1	O RING EPDM				
86	1	O RING EPDM				
87	8	COIL SPRING (OS12/14/16)				
	10	COIL SPRING (OS22/24/26/32/34/36)				
	16	COIL SPRING (OS42/44/46)				
92	1	O RING EPDM				
93	1	DRIVE RING, ASSY OUTER DBL / SLEEVE				
94	1	ROTARY HOLDER DBL				

Pos	Qty	Denomination	OS12/14/16 FPM	OS22/24/26 FPM	OS32/34/36 FPM	OS42/44/46 FPM
	•	Complete Double Seal SC/SC/SC/C FPM:	9650109582	9650209582	9650309582	9650409582
71	1	ROTARY HOLDER DBL EPDM				
72	1	STATIC/ROTARY FACE SC				
73	1	STATIC/ROTARY FACE SC				
74	1	HOUSING DOUBLE SS				
75	1	DRIVE RING ASSY INNER DBL				
76	1	STATIC FACE DOUBLE SC				
77	1	ROTARY FACE DOUBLE CARBON				
78	1	DRIVE RING ASSY OUTER DBL				
79	1	CIRCLIP DOUBLE HOUSING				
80	1	P RING FPM				
81	1	WASHER PTFE				
82	1	P RING FPM				
83	1	P RING FPM				
84	1	O RING FPM				
85	1	O RING FPM				
86	1	O RING FPM				
87	8	COIL SPRING (OS12/14/16)				
	10	COIL SPRING (OS22/24/26/32/34/36)				
	16	COIL SPRING (OS42/44/46)				
92	1	O RING FPM				
93	1	DRIVE RING, ASSY OUTER DBL / SLEEVE				
94	1	ROTARY HOLDER DBL				

Pos	Qty	Denomination	OS12/14/16 FFPM	OS22/24/26 FFPM	OS32/34/36 FFPM	OS42/44/46 FFPM
	•	Complete Double Seal SC/SC/SC/C FFPM:	9650109583	9650209583	9650309583	9650409583
71	1	ROTARY HOLDER DBL EPDM				
72	1	STATIC/ROTARY FACE SC				
73	1	STATIC/ROTARY FACE SC				
74	1	HOUSING DOUBLE SS				
75	1	DRIVE RING ASSY INNER DBL				
76	1	STATIC FACE DOUBLE SC				
77	1	ROTARY FACE DOUBLE CARBON				
78	1	DRIVE RING ASSY OUTER DBL				
79	1	CIRCLIP DOUBLE HOUSING				
80	1	P RING FFPM				
81	1	WASHER PTFE				
82	1	P RING FFPM				
83	1	P RING FFPM				
84	1	O RING FFPM				
85	1	O RING FFPM				
86	1	O RING FFPM				
87	8	COIL SPRING (OS12/14/16)				
	10	COIL SPRING (OS22/24/26/32/34/36)				
	16	COIL SPRING (OS42/44/46)				
92	1	O RING FFPM				
93	1	DRIVE RING, ASSY OUTER DBL / SLEEVE				
94	1	ROTARY HOLDER DBL				

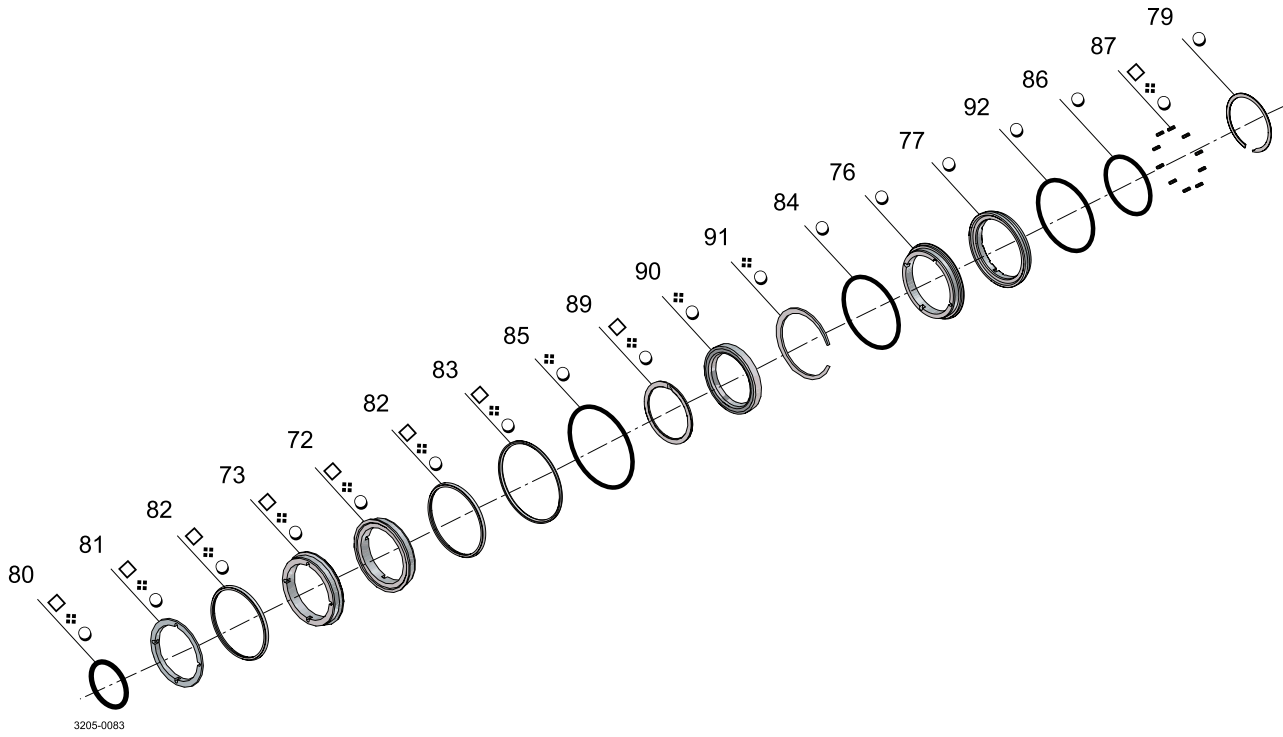

Seal Kit

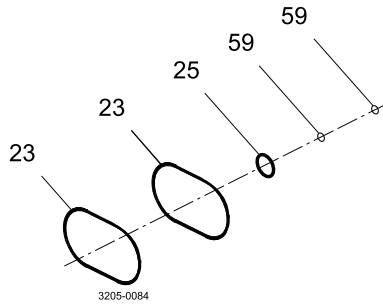

Wet End Elastomer Kit

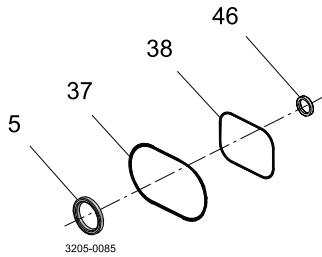

Gearbox Elastomer Kit

	EPDM	FPM	FFPM
Seal Service Kits allow rebuilding of the existing cartridge seals, containing only the consumable parts. For servicing complete pump 2 pcs. seal service kits are required.			
Service Kits for Single Seal OSC SC/C			
□	Service Kit, OSC SC/C (OS12/14/16)	9650109601	9650109602 9650109603
□	Service Kit, OSC SC/C (OS22/24/26)	9650209601	9650209602 9650209603
□	Service Kit, OSC SC/C (OS32/34/36)	9650309601	9650309602 9650309603
□	Service Kit, OSC SC/C (OS42/44/46)	9650409601	9650409602 9650409603
Service Kits for Single Seal OSC SC/SC			
□	Service Kit, OSC SC/SC (OS12/14/16)	9650109611	9650109612 9650109613
□	Service Kit, OSC SC/SC (OS22/24/26)	9650209611	9650209612 9650209613
□	Service Kit, OSC SC/SC (OS32/34/36)	9650309611	9650309612 9650309613
□	Service Kit, OSC SC/SC (OS42/44/46)	9650409611	9650409612 9650409613
		EPDM Flushed	FPM Flushed FFPM Flushed
Service Kits for Single Flushed Seal OSC SC/C			
❖	Service Kit, OSC SC/C (OS12/14/16)	9650109651	9650109652 9650109653
❖	Service Kit, OSC SC/C (OS22/24/26)	9650209651	9650209652 9650209653
❖	Service Kit, OSC SC/C (OS32/34/36)	9650309651	9650309652 9650309653
❖	Service Kit, OSC SC/C (OS42/44/46)	9650409651	9650409652 9650409653
Service Kits for Single Flushed Seal OSC SC/SC			
❖	Service Kit, OSC SC/SC (OS12/14/16)	9650109661	9650109662 9650109663
❖	Service Kit, OSC SC/SC (OS22/24/26)	9650209661	9650209662 9650209663
❖	Service Kit, OSC SC/SC (OS32/34/36)	9650309661	9650309662 9650309663
❖	Service Kit, OSC SC/SC (OS32/34/36)	9650409661	9650409662 9650409663
Service Kits for Double Flushed Seal OSC SC/C v SC/C			
○	Service Kit, OSC SC/C v SC/C (OS12/14/16)	9650109671	9650109672 9650109673
○	Service Kit, OSC SC/C v SC/C (OS22/24/26)	9650209671	9650209672 9650209673
○	Service Kit, OSC SC/C v SC/C (OS32/34/36)	9650309671	9650309672 9650309673
○	Service Kit, OSC SC/C v SC/C (OS42/44/46)	9650409671	9650409672 9650409673
Service Kits for Double Flushed Seal OSC SC/SC v SC/C			
○	Service Kit, OSC SC/SC v SC/C (OS12/14/16)	9650109681	9650109682 9650109683
○	Service Kit, OSC SC/SC v SC/C (OS22/24/26)	9650209681	9650209682 9650209683
○	Service Kit, OSC SC/SC v SC/C (OS32/34/36)	9650309681	9650309682 9650309683
○	Service Kit, OSC SC/SC v SC/C (OS42/44/46)	9650409681	9650409682 9650409683
Service Kits for Wet End Elastomer kit (1 pcs. required per pump unit)			
▲	Service Kit, Wet End Elastomer (OS12/14/16)	9650109701	9650109702 9650109703
▲	Service Kit, Wet End Elastomer (OS22/24/26)	9650209701	9650209702 9650209703
▲	Service Kit, Wet End Elastomer (OS32/34/36)	9650309701	9650309702 9650309703
▲	Service Kit, Wet End Elastomer (OS42/44/46)	9650409701	9650409702 9650409703
Service Kits for Gearbox Elastomer kit (1 pcs. required per pump unit)			
△	Service Kit, Gearbox Elastomer (OS12/14/16)	9650109801	
△	Service Kit, Gearbox Elastomer (OS22/24/26)	9650209801	
△	Service Kit, Gearbox Elastomer (OS32/34/36)	9650309801	
△	Service Kit, Gearbox Elastomer (OS42/44/46)	9650409801	
Commisioning Plugs (1 pcs. required per pump unit)			
	Commisioning Plugs (OS12/14/16)	9650109401	
	Commisioning Plugs (OS22/24/26)	9650209401	
	Commisioning Plugs (OS32/34/36)	9650209401	

Twin Screw Service Kits

**EPDM
Flushed** **FPM
Flushed** **FFPM
Flushed**

Commisioning Plugs (OS42/44/46) 9650209401

How to contact Alfa Laval

Contact details for all countries are continually updated on our website.

Please visit www.alfalaval.com to access the information directly.

© Alfa Laval Corporate AB

This document and its contents is owned by Alfa Laval Corporate AB and protected by laws governing intellectual property and thereto related rights. It is the responsibility of the user of this document to comply with all applicable intellectual property laws. Without limiting any rights related to this document, no part of this document may be copied, reproduced or transmitted in any form or by any means (electronic, mechanical, photocopying, recording, or otherwise), or for any purpose, without the expressed permission of Alfa Laval Corporate AB. Alfa Laval Corporate AB will enforce its rights related to this document to the fullest extent of the law, including the seeking of criminal prosecution.