

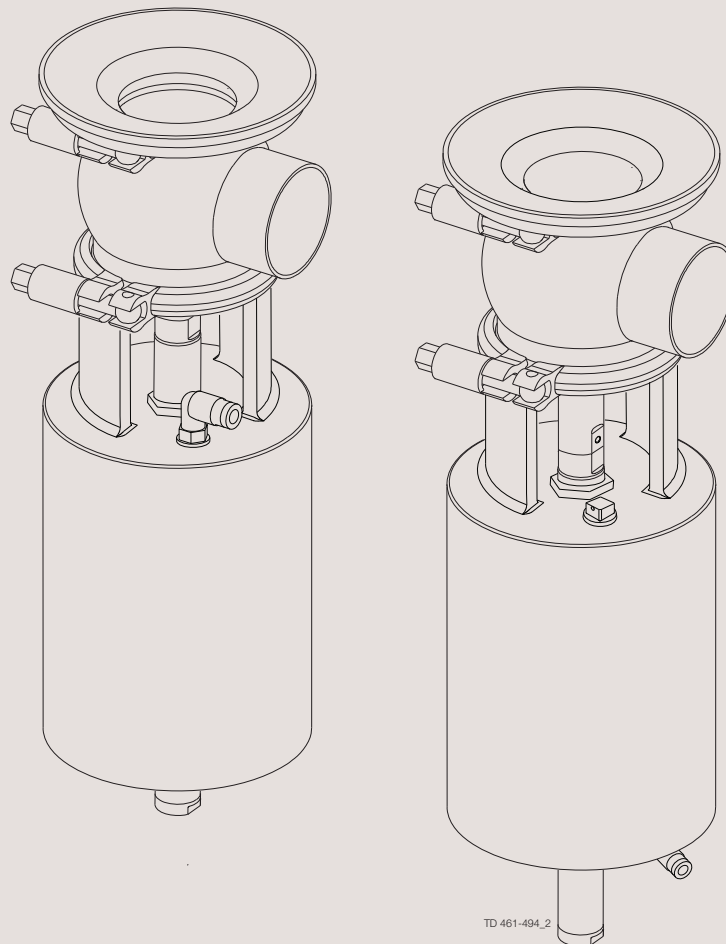

Spare Parts

Unique Single Seat Valve - Tank Outlet



TD 461-494_2

ESE00676-EN7 2018-11

Original manual

Table of contents

The information herein is correct at the time of issue but may be subject to change without prior notice

1. Important information	4
2. Unique Single Seat Valve - Tank Outlet Valve 51-101.6 mm/DN50-100	6
3. Unique Single Seat Valve - RA Tank Outlet Valve 51-101.6 mm/DN50-100	8
4. Mounting Tool - Unique Single Seat Valve - Tank Outlet Valve	10



1 Important information

Different actuator types for the SSV valve

In June 2016 the below change was implemented and the "removable yoke with bolts" version is thereby phased out and replaced by the "yoke without bolts" version.

NOTE

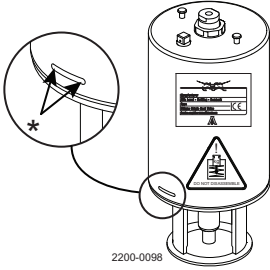
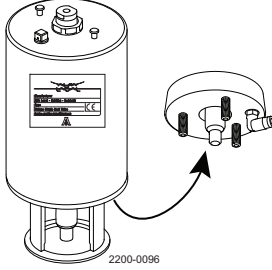
It is important to check for warnings marked on the actuator when servicing an actuator- see below table.

<p>Actuator type</p>	<p>Non-maintable actuator Spring under load and can NOT be opened</p>  <p>*) Lock wire opening is locked, when warning is marked on actuator</p>	<p>Fully maintainable actuator Spring cage and can be opened</p> 	<p>Fully maintainable actuator Spring cage and can be opened</p> 
<p>Yoke type</p>	<p>Non-removable yoke</p>	<p>"Removable yoke with bolts". If the yoke with bolts is damaged it has to be replaced by the "yoke without bolts"</p>	<p>"Yoke without bolts"</p>
<p>Service</p>	<p>Not possible to service internally (it is not possible to change piston o-rings)</p>	<p>Yes</p>	<p>Yes</p>
<p>Marked with warnings</p>	<p>Yes</p>	<p>No</p>	<p>No</p>
<p>Year of production</p>	<p>From 2006</p>	<p>From 2006 - June 2016</p>	<p>From June 2016</p>

Unique Single Seat Valve - Tank Outlet Valve 51-101.6 mm/DN50-100

If the actuator is marked with a danger warning do **NOT** attempt to cut the actuator open.



Do **NOT** attempt to disassemble the actuator due to spring under load danger!



Do **NOT** attempt to cut the actuator open, due to spring under load danger!

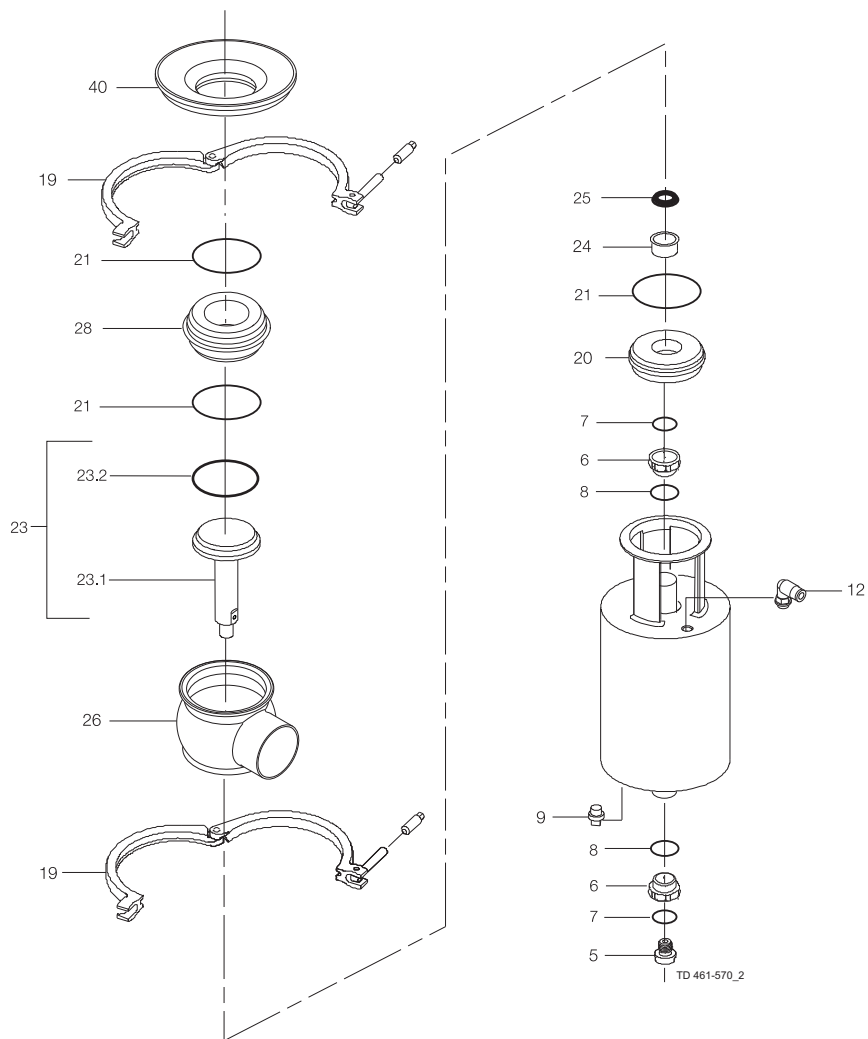

Unique Single Seat Valve - Tank Outlet Valve 51-101.6 mm/DN50-100

Pos	Qty	Denomination	DN 50 51 mm	DN 65 63.5 mm	DN 80 76.1 mm	DN 100 101.6 mm
Actuator						
		Actuator, complete (NO)	9613154802	9613154803	9613154804	9613154805
		Actuator, complete (NC)	9613154807	9613154808	9613154809	9613154810
		Actuator, complete (A/A)	9613154812	9613154813	9613154814	9613154815
5	1	Adapter, plastic (- 0115)				
	1	Adapter, steel (0115 - 0518)				
	1	Adapter, steel (0518 -)	9615374701	9615374701	9615374701	9615374701
6	□ 2	Bushing				
7	□ 2	O-ring				
8	□ 2	O-ring				
9	1	Plug	9613414101	9613414101	9613414101	9613414101
12	1(2)	Air fitting	9611991988	9611991988	9611991988	9611991988
Clamp						
19	2	Clamp	9612939304	9612939305	9612939306	9612939307
Bonnet						
20	1	Bonnet	9613127103	9613127104	9613127105	9613127106
21	♦ 3	O-ring, EPDM (standard)				
	3	O-ring, HNBR				
	3	O-ring, FPM				
		O-ring set (10 pcs.) EPDM	9614059425	9614059428	9614059431	9614059434
		O-ring set (10 pcs.) HNBR	9614059426	9614059429	9614059432	9614059435
		O-ring set (10 pcs.) FPM	9614059427	9614059430	9614059433	9614059436
24	1	Bushing	9613125002	9613125002	9613125002	9613125002
25	♦ 1	Lip seal, EPDM (standard)				
	1	Lip seal, HNBR				
	1	Lip seal, FPM				
		Lip seal set (10 pcs.) EPDM	9614059419	9614059419	9614059419	9614059419
		Lip seal set (10 pcs.) HNBR	9614059420	9614059420	9614059420	9614059420
		Lip seal set (10 pcs.) FPM	9614059421	9614059421	9614059421	9614059421
Seat						
28	1	Seat	9613127503	9613127504	9613127505	9613127506
Valve Body						
26	1	Valve body, upper, 1 port ISO	9613139305	9613139307	9613139309	9613139311
	1	Valve body, upper, 2 ports ISO	9613139306	9613139308	9613139310	9613139312
	1	Valve body, upper, 1 port DIN	9613139405	9613139407	9613139409	9613139411
	1	Valve body, upper, 2 ports DIN	9613139406	9613139408	9613139410	9613139412
Tank flange						
40	1	Tank flange	9634069901	9634070001	9634070101	9634070201
Valve Plug						
23	1	Plug, shut-off, ISO, complete, EPDM (standard)	9613138803	9613138804	9613138805	9613138806
	1	Plug, shut-off, ISO, complete, HNBR	9613138815	9613138816	9613138817	9613138818
	1	Plug, shut-off, ISO, complete, FPM	9613138827	9613138828	9613138829	9613138830
	1	Plug, shut-off, DIN, complete, EPDM (standard)	9613138809	9613138810	9613138811	9613138812
	1	Plug, shut-off, DIN, complete, HNBR	9613138821	9613138822	9613138823	9613138824
	1	Plug, shut-off, DIN, complete, FPM	9613138833	9613138834	9613138835	9613138836
23.1	1	Plug, shut-off, ISO	9613139803	9613139804	9613139805	9613139806
	1	Plug, shut-off, DIN	9613139809	9613139810	9613139811	9613139812
23.2♦	1	Plug seal, EPDM (standard)				
	1	Plug seal, HNBR				
	1	Plug seal, FPM				
		Plug seal set (10 pcs.) EPDM	9614059407	9614059410	9614059413	9614059416
		Plug seal set (10 pcs.) HNBR	9614059408	9614059411	9614059414	9614059417
		Plug seal set (10 pcs.) FPM	9614059409	9614059412	9614059415	9614059418
			DN 50	DN 65	DN 80	DN 100
			51 mm	63.5 mm	76.1 mm	101.6 mm

Service kit for actuator

□	Service kit, actuator	9611926500	9611926500	9611926500	9611926500
♦	Service kit, EPDM	9611926701	9611926702	9611926703	9611926704
♦	Service kit, HNBR	9611926705	9611926706	9611926707	9611926708
♦	Service kit, FPM	9611926709	9611926710	9611926711	9611926712

Parts marked with □♦ are included in the service kits.

Recommended spare parts: Service kits.

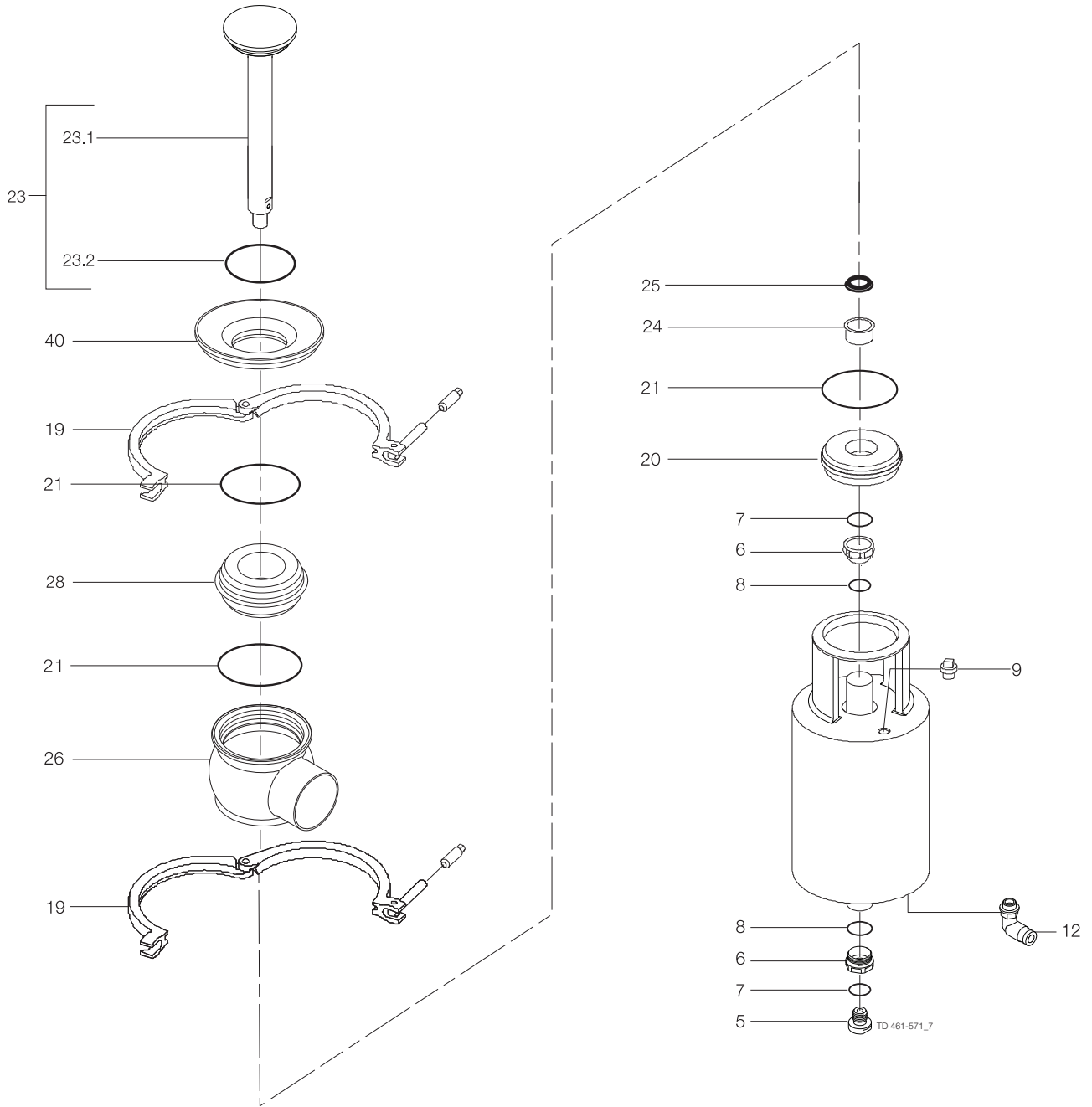

Unique Single Seat Valve - RA Tank Outlet Valve 51-101.6 mm/DN50-100

Pos	Qty	Denomination	DN 50 51 mm	DN 65 63.5 mm	DN 80 76.1 mm	DN 100 101.6 mm
Actuator						
		Actuator, complete (NO-RA)	9613154807	9613154808	9613154809	9613154810
		Actuator, complete (NC-RA)	9613154802	9613154803	9613154804	9613154805
		Actuator, complete (A/A)	9613154812	9613154813	9613154814	9613154815
5	1	Adapter, plastic (- 0115)				
	1	Adapter, steel (0115 - 0518)				
	1	Adapter, steel (0518 -)	9615374701	9615374701	9615374701	9615374701
6	□ 2	Bushing				
7	□ 2	O-ring				
8	□ 2	O-ring				
9	1	Plug	9613414101	9613414101	9613414101	9613414101
12	1(2)	Air fitting	9611991988	9611991988	9611991988	9611991988
Clamp						
19	2	Clamp	9612939304	9612939305	9612939306	9612939307
Bonnet						
20	1	Bonnet	9613127103	9613127104	9613127105	9613127106
21	◆ 3	O-ring, EPDM (standard)				
	3	O-ring, HNBR				
	3	O-ring, FPM				
		O-ring set (10 pcs.) EPDM	9614059425	9614059428	9614059431	9614059434
		O-ring set (10 pcs.) HNBR	9614059426	9614059429	9614059432	9614059435
		O-ring set (10 pcs.) FPM	9614059427	9614059430	9614059433	9614059436
24	1	Bushing	9613125002	9613125002	9613125002	9613125002
25	◆ 1	Lip seal, EPDM (standard)				
	1	Lip seal, HNBR				
	1	Lip seal, FPM				
		Lip seal set (10 pcs.) EPDM	9614059419	9614059419	9614059419	9614059419
		Lip seal set (10 pcs.) HNBR	9614059420	9614059420	9614059420	9614059420
		Lip seal set (10 pcs.) FPM	9614059421	9614059421	9614059421	9614059421
Seat						
28	1	Seat	9613127503	9613127504	9613127505	9613127506
Valve Body						
26	1	Valve body, upper, 1 port ISO	9613139305	9613139307	9613139309	9613139311
	1	Valve body, upper, 2 ports ISO	9613139306	9613139308	9613139310	9613139312
	1	Valve body, upper, 1 port DIN	9613139405	9613139407	9613139409	9613139411
	1	Valve body, upper, 2 ports DIN	9613139406	9613139408	9613139410	9613139412
Tank flange						
40	1	Tank flange	9634069901	9634070001	9634070101	9634070201
Valve Plug						
23	1	Plug, shut-off RA, ISO, complete, EPDM (standard)	9613127603	9613127604	9613127605	9613127606
	1	Plug, shut-off RA, ISO, complete, HNBR	9613127615	9613127616	9613127617	9613127618
	1	Plug, shut-off RA, ISO, complete, FPM	9613127627	9613127628	9613127629	9613127630
	1	Plug, shut-off RA, DIN, complete, EPDM (standard)	9613127609	9613127610	9613127611	9613127612
	1	Plug, shut-off RA, DIN, complete, HNBR	9613127621	9613127622	9613127623	9613127624
	1	Plug, shut-off RA, DIN, complete, FPM	9613127633	9613127634	9613127635	9613127636
23.1	1	Plug, shut-off RA, ISO	9613139903	9613139904	9613139905	9613139906
	1	Plug, shut-off RA, DIN	9613139909	9613139910	9613139911	9613139912
23.2◆	1	Plug seal, EPDM (standard)				
	1	Plug seal, HNBR				
	1	Plug seal, FPM				
		Plug seal set (10 pcs.) EPDM	9614059407	9614059410	9614059413	9614059416
		Plug seal set (10 pcs.) HNBR	9614059408	9614059411	9614059414	9614059417
		Plug seal set (10 pcs.) FPM	9614059409	9614059412	9614059415	9614059418
<hr/>						
			DN 50 51 mm	DN 65 63.5 mm	DN 80 76.1 mm	DN 100 101.6 mm

Service kit for actuator

□	Service kit, actuator	9611926500	9611926500	9611926500	9611926500
◆	Service kit, EPDM	9611926701	9611926702	9611926703	9611926704
◆	Service kit, HNBR	9611926705	9611926706	9611926707	9611926708
◆	Service kit, FPM	9611926709	9611926710	9611926711	9611926712

Parts marked with □◆ are included in the service kits.

Recommended spare parts: Service kits.

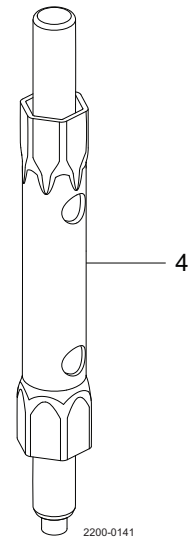
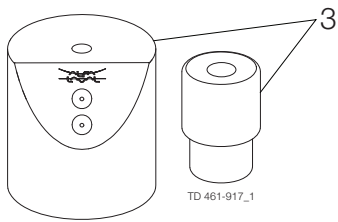
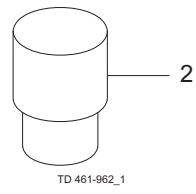
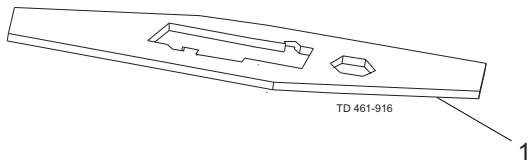

Mounting Tool - Unique Single Seat Valve - Tank Outlet Valve

Pos	Qty	Denomination	DN 25-65	DN 80-150
			25-63.5 mm	76.1-101.6 mm
1	1	Tool for bushing (pos. 24)	3135302191	9612454001

TD 900-512

Pos	Qty	Denomination	DN 25-100
			25-101.6 mm
2	1	Tool for bushing (pos. 24)	9613160901

TD 900-518

Pos	Qty	Denomination	DN 25	DN 40	DN 50	DN 65	DN 80	DN 100
			25 mm	38 mm	51 mm	63.5 mm	76.1 mm	101.6 mm
3	1	Mounting tool for elastomer plug seals	Not available	9613172901	9613172902	9613172902	9613172903	9613172903

TD 900-520

Pos	Qty	Denomination	DN 25-100
			25-101.6 mm
4	1	Tool for actuator bushing (pos. 6)	9614198401

TD 900-701

How to contact Alfa Laval

Contact details for all countries are continually updated on our website.

Please visit www.alfalaval.com to access the information directly.

© Alfa Laval Corporate AB

This document and its contents is owned by Alfa Laval Corporate AB and protected by laws governing intellectual property and thereto related rights. It is the responsibility of the user of this document to comply with all applicable intellectual property laws. Without limiting any rights related to this document, no part of this document may be copied, reproduced or transmitted in any form or by any means (electronic, mechanical, photocopying, recording, or otherwise), or for any purpose, without the expressed permission of Alfa Laval Corporate AB. Alfa Laval Corporate AB will enforce its rights related to this document to the fullest extent of the law, including the seeking of criminal prosecution.